

inspiro Premium DynaMic

User Guide



PHONAK

life is on

Contents

1. Welcome	6
2. inspiro and accessoires	8
3. Important inspiro figures	9
3.1 Operating time and charging	9
3.2 Operating range (FM transmission)	9
4. Controls	10
5. Getting started	12
5.1 Charging inspiro	12
5.2 Low battery alarms	14
5.3 Wearing inspiro	15
5.4 Attaching the clip to the inspiro	16
5.5 Attaching the lavalier to the inspiro	18
5.6 Wearing iLapel microphone	19
5.7 iLapel wearing position	20
5.8 Wearing EasyBoom microphone	21
5.9 Switching ON inspiro	23
5.10 Activate the key pad lock	24
5.11 Monitoring	25

6. Using inspiro	27
6.1 Talking	27
6.2 SoundCheck	28
6.3 Muting the microphone	29
6.4 Using inspiro with an MP3 player, TV set, GPS, computer or HiFi	30
6.5 Synchronizing receivers	32
7. Individual inspiro configuration	33
7.1 Setting the alarm time	33
7.2 Setting the preferred date format	34
7.3 Adjusting the settings of the LCD display	35
7.4 Selecting a desktop picture	36
7.5 Selecting your language	37
8. Brief description of the menu items	38
8.1 Channels	38
8.2 Receiver options	39
8.3 SoundCheck	40
8.4 Settings	40
8.5 Help	42
8.6 MultiTalker Network	43
8.7 Receiver options	44
9. Changing the application mode	45

Contents

10. DynaMic and accessories	46
11. Important DynaMic figures	47
11.1 Operating time and charging	47
11.2 Operating range (FM transmission)	47
12. Controls	48
13. Getting started	49
13.1 Charging DynaMic	49
13.2 Battery status indication	50
13.3 Vibration alarm indication	51
13.4 Switching ON DynaMic	52
14. Using DynaMic	54
14.1 Common use situations	54
14.2 Passaround microphone	54
14.3 Talking	54
14.4 Colored rings	55
14.5 DynaMic DataLogging FM	55
14.6 Programming	55
15. The MultiTalker Network in school	56
15.1 The MultiTalker Network	56
15.2 Initiating a MultiTalker Network	57
15.3 How to use a MultiTalker Network	58

15.4 Leaving a MultiTalker Network	58
15.5 Practical tips	59
15.6 Setting up a MultiTalker Network when using DigiMaster loudspeaker	60
16. FM receivers	61
16.1 The MLxi	61
16.2 Lock MLxi push button	62
16.3 Identifying receivers	62
16.4 Other Phonak FM receivers	63
17. Troubleshooting	64
17.1 inspiro	64
17.2 DynaMic	68
18. Important notices	72
19. Service and warranty	74
20. Declaration of conformity	75
21. Information and explanation of symbols	76

1. Welcome

inspiro and DynaMic are FM transmitters ideally suited to the needs of teachers and suitable for use in both regular and special schools.

inspiro's outstanding design, with its large color display, makes this transmitter unique. Soft keys, an alarm clock, different wearing options and a wealth of other details reflect Phonak's passion for user friendliness.

DynaMic, the inspiro passaround microphone, is designed to work exclusively alongside inspiro in the MultiTalker Network. With its simple, robust and childproof design DynaMic integrates inspiro's high performance FM technology.

Please read this manual carefully to benefit from all the features of your inspiro and DynaMic FM transmitters. Ask your hearing care professional if you have any questions.

With proper care and usage, inspiro and DynaMic will support your hearing and communication needs for many years.

inspiro and DynaMic are quality products developed by Phonak. Phonak is the world leader in FM technology, innovation and reliability based in Switzerland.

Phonak – Life is on

Further resources:

To find out more about inspiro, DynaMic, and Phonak FM in general, we recommend visiting the following websites:

- **www.eschooldesk.com**

This is a special website specifically dedicated to providing support to teachers, parents and other inspiro and DynaMic users. The short movies available present for example various functions and trouble shooting for FM systems aim to provide assistance in daily life.

- **www.phonak.com**

This is Phonak home page. Go on the product section and click on the FM systems. You can find useful information about inspiro and DynaMic as well as FM receivers.

- **www.fmelibrary.com**

This is an online scientific library about FM systems.

The following symbol appears in this user guide:

 Important notes for all users.

2. inspiro and accessoires

inspiro is delivered with either the EasyBoom or the iLapel microphone, depending on the customer wish. All the accessories can also be ordered separately.

① inspiro _____



② Microphones: EasyBoom or iLapel _____



③ inspiro wearing options:
Belt clip and lavalier cord _____



④ Audio cable _____



⑤ USB charging unit _____



⑥ Home and travel case _____



3. Important inspiro figures

3.1 Operating time and charging

- Operating time when the battery is fully charged:
 - ▷ approx. 12 hours
- Charging time for an 80% charge:
 - ▷ approx. 1 hour
- Charging time for a 100% charge:
 - ▷ approx. 2 hours

3.2 Operating range (FM transmission)

- Inside a building:
 - ▷ approx. 15 meters / 50 feet
 - Outside:
 - ▷ approx. 40-50 meters / 130-170 feet
- ⚠ High-powered electronic equipment, large electronic installations and metallic structures may impair and significantly reduce the operating range.**

4. Controls



inspiro

- ① ON/OFF slider
- ② Color LCD
- ③ Soft keys
- ④ Keypad lock key
- ⑤ Microphone mute key



- ⑥ 3.5 mm audio input
- ⑦ mini-USB for charging



- ⑧ Button to attach the belt clip and the lavalier
- ⑨ Cable wrapper



iLapel microphone

- ⑩ Microphone openings (do not cover!)
- ⑪ Wearing clip



EasyBoom microphone

- ⑫ Microphone

5. Getting Started

5.1 Charging inspiro

inspiro contains a re-chargeable built-in state-of-the-art lithium polymer battery with fast-charge capability. A fully-discharged battery will charge to 80% in one hour and 100% in 2 hours.

Select an easily accessible socket outlet and plug the charging unit into the socket outlet.

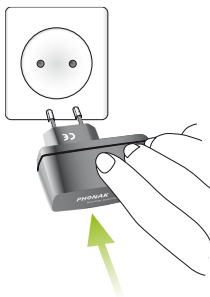

Connect the mini-USB plug from the charging unit to the inspiro.

⚠ Use only the original Phonak charging unit for insprio.

The segments in the battery symbol flash during charging. The battery cannot be over-charged.



If the charging unit is removed from the insprio, the battery symbol shows the actual capacity.



The battery is fully charged.

5. Getting Started

5.2 Low battery alarms

inspiro provides an automatic vibra alarm if the battery is low.

- **Approximately 1 hour before battery is empty:**
A vibrating alarm is activated. Check the message on the LCD and follow the instructions.
- **Approximately 15 minutes before battery is empty:**
If inspiro has not been charged after the first alarm, the second vibrating alarm is automatically activated before the battery is completely exhausted. Check the message on the LCD and follow the instructions. If the battery is not being charged at that time, inspiro switches OFF automatically in 15 minutes.

If the battery is completely exhausted, there will be no segments in the battery symbol and the battery symbol in the LCD will change from white to red.

5.3 Wearing inspiro

inspiro can either
be worn on the belt
by using the clip...

...or around the neck
by using the lavalier

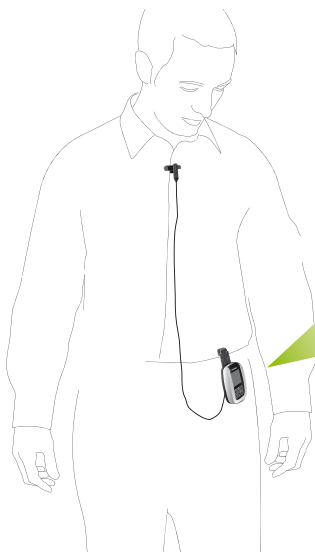

(see page 16)

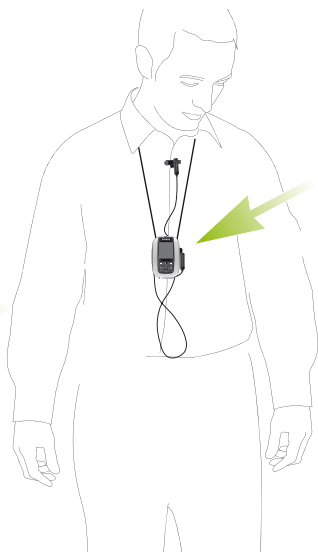

(see page 18)

5. Getting Started

5.4 Attaching the clip to the inspiro



Attach the clip to the button on the backside of the inspiro. Make sure the clip holds securely on the inspiro.

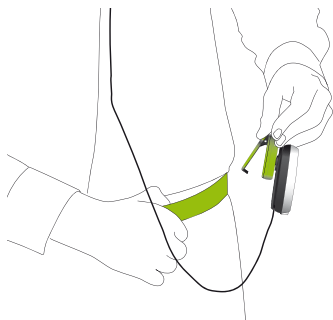

Fix the clip to the belt or trousers. Make sure the clip on the inspiro holds securely.

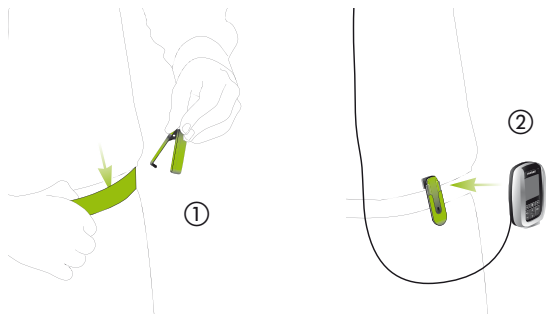

The clip can also be fixed to the belt or trousers before the inspiro is attached. Make sure the clip is secured to the inspiro.

To remove the clip from the inspiro, press the button on the clip and carefully remove the clip from the inspiro.

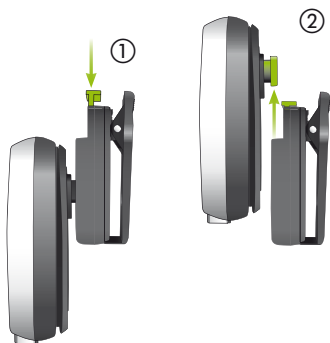

5. Getting Started

5.5 Attaching the lavalier to the inspiro

Attach the lavalier to the button

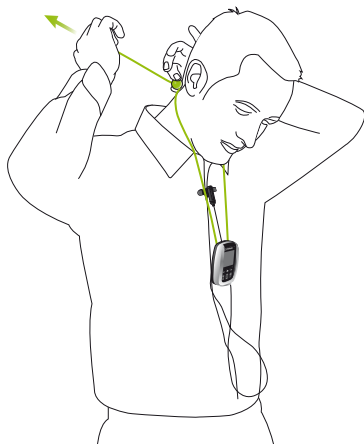

5.6 Wearing iLapel microphone

iLapel is an easy-to-use directional lapel microphone which provides excellent sound quality.

⚠ You must switch OFF inspiro before changing the microphone.

a) Unwind the iLapel from the inspiro.



b) Fix the iLapel to your shirt and make sure the distance between the microphone and your mouth is approximately 20 cm / 7 inches.

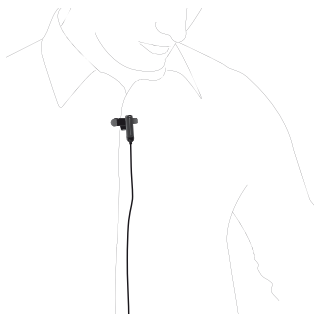

5. Getting Started

5.7 iLapel wearing position

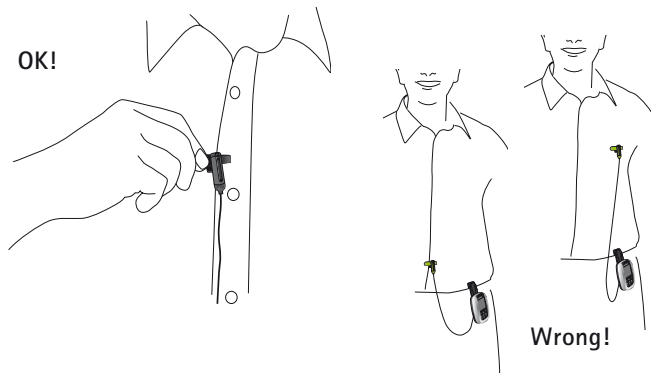

⚠ Do not cover the two microphone openings!

If you are uncertain whether the iLapel is in the correct position, activate the SoundCheck feature in inspiro. SoundCheck helps to position the iLapel correctly.

5.8 Wearing EasyBoom microphone

EasyBoom is a comfortable, easy-to-use and robust boom microphone, ideal for use in classrooms.

⚠ You must switch OFF inspiro before changing the microphone.

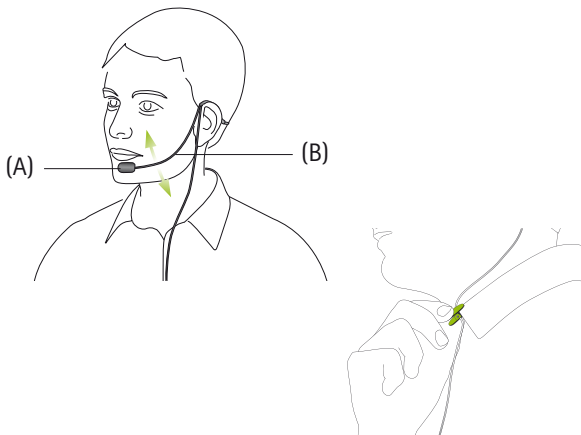

5. Getting Started

Make sure the head of the microphone is well positioned, as depicted on page 21 (A). If required you can easily bend the boom part (B).

Fix the clip on your clothes as depicted and make sure the cable is not stretched between the clip and the ear, or the clip and the inspiro transmitter.

I



II



III



5.9 Switching ON inspiro

To switch ON, push the slider to the left until the green mark appears and the LCD is illuminated.

To save power, the backlight of the inspiro LCD is switched OFF after a certain time. Press any button to activate the LCD backlight.

To switch OFF inspiro, push the slider to the right.



⚠ The inspiro can also be switched OFF if the keypad is locked!

5. Getting Started

5.10 Activate the key pad lock

It is recommended to activate the key pad lock whenever possible.

To activate the key pad lock, go to the highest menu level as shown above and press the key showing the key symbol, then press OK. A key symbol appears in the status bar.

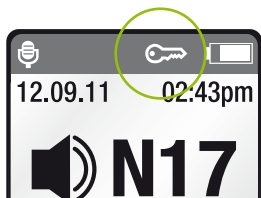

⚠ If the key pad lock is activated, the six keys are locked. These remain locked when using the ON/OFF slider. Please note that the ON/OFF slider is never locked and can always be used!

To unlock the keys, repeat the above procedure.

5.11 Monitoring

Monitoring is a simple and easy way to check the functionality of FM receivers. We recommend monitoring receivers every day. By pressing the Monitor soft key, the inspiro reads the information from a child's FM receivers (one or two FM receivers).

The procedure is as follows:

- Hold the inspiro close to the child, at a distance of approximately 20 cm / 8 inches from the receivers. Ensure that no other receivers are within synchronisation range.
- Then press the left soft key **Monitor** at the top Menu level. The inspiro then begins to search for receivers. Make sure you are within synchronisation range until the receivers are shown on the inspiro's LCD display.
- The result of the Monitoring process will be displayed on the inspiro's LCD display. The completion of the Monitoring process is marked with a beeping sound.
If the beeping sound cannot be heard in the hearing device, the child's hearing device is probably not in an FM program. Contact your Hearing care professional on matters concerning the right hearing instrument program for FM.

5. Getting Started



- In order to view detailed Monitoring results, select the desired receiver on the inspiro LCD display and press the OK key. For the purpose of this step, you no longer need to be close to the receiver.

⚠ Monitoring will only be performed if the receiver is connected to the hearing device and the receiver and the hearing instrument are turned ON.

⚠ Monitoring will only work with Phonak Dynamic FM receivers, like MLxi, MyLink+, ML9i, ML10i, ML11i, etc. and MLxi Baha. If you are not sure that your receivers are Phonak Dynamic FM receivers, ask your hearing care professional.

6. Using inspiro

6.1 Talking

Before you start talking to the children, make sure of the following:

- the microphone is properly positioned (see page 20 and 22)
- the inspiro is turned ON (see page 23)
- and the microphone is active, not muted (see page 29)

We also recommend activating the keypad lock.

⚠ Do not touch the microphone if the inspiro is turned ON.
If you need to reposition the microphone, simply press the microphone mute key to avoid any amplified noise.



6.2 SoundCheck

The SoundCheck lets you verify whether the microphone is properly positioned, as well as checking the noise level in the classroom. The required procedure is as follows:

- Activate the SoundCheck in the top menu level. Then follow the instructions shown on the inspiro's LCD display.
- Talk continuously until the inspiro stops measuring.



The inspiro will show two results:

- If the level of your voice is good, this will be indicated with a green bar. If the bar is yellow or red, however, you may need to reposition the microphone or to speak more loudly.
- If the noise level in the room is in the red or yellow zone, discuss with your hearing care professional whether there are possibilities to improve the acoustics in the classroom.

6.3 Muting the microphone

The inspiro's microphone can be muted simply by pressing the microphone key on the device. If you have forgotten to activate the microphone, inspiro will warn you with a vibrating alarm after 15 minutes.





- This symbol shows that the microphone is active: 
- This symbol shows that the microphone has been muted: 

6. Using inspiro

6.4 Using the inspiro with an MP3 player, TV set, GPS, computer or Hifi

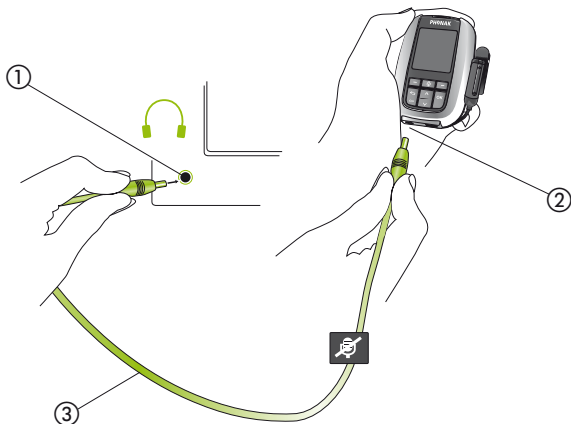
The inspiro can be directly connected to any audio equipment via the audio input socket on the inspiro.



- ① Plug in to the television's headphone jack
- ② Plug in to the audio jack  AUDIO
- ③ Audio cable (standard accessory)

-
- If the audio cable is plugged in, the audio symbol appears on the inspiro's LCD display. 
 - The microphone can still be activated when the audio input is connected.
 - Some televisions are equipped with a separate audio output volume control, or a muting function. Please refer to the television's operating instructions for details.
 - Certain pieces of audio equipment feature a Scart or Cinch audio output. Phonak offers an optional adapter for connecting the audio cable to Scart or Cinch sockets.

Scart adapter

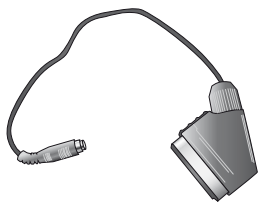

Cinch adapter

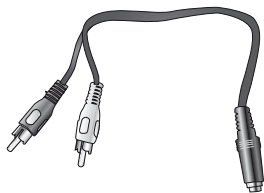

 Unwind the microphone cable in order to reach the maximum operating distance.

6. Using inspiro

6.5 Synchronizing receivers

If you change the channel of the inspiro transmitter, you should always make sure that the channel of the receivers is synchronized to the new inspiro channel. In order to synchronize the receivers, the inspiro needs to be close to the receivers (at a distance of approximately 20 cm / 8 inches).

- Follow the instructions shown on the inspiro, for example if you change the inspiro channel or if you activate the Channel Finder.
- In the top screen, you can have direct access to the synchronization feature by pressing the right soft key labeled "Sync" (default settings).



- The Monitoring feature (see page 25) also checks whether the receivers are on the same channel as the inspiro.

7. Individual inspiro configuration

7.1 Setting the alarm time

The inspiro includes an alarm function. As with mobile phones, an alarm time can be entered and the alarm can be either activated or deactivated.

 **The alarm will only be displayed if the inspiro is switched on!**

In order to set an alarm time, proceed as follows:

- Enter the **Settings** menu and then select **Alarm**.
- Select **Alarm time** and then press **OK**. Using the **Up** and **Down** keys, you can set the first digit of the alarm time. After pressing **OK**, the cursor then moves to the next digit. If the complete time has been entered, press **Save**.
- Then select **Set Alarm**.
- Select **On** and then press **OK**.

The alarm time has now been set and the alarm has been activated. This is confirmed by the presence of the bell symbol in the top part of the screen. 

If an alarm sounds, the inspiro will vibrate and a message will pop up on the screen. Confirm this message using the **OK** button.

7. Individual inspiro configuration

7.2 Setting the preferred date format

A choice of two date formats is available on the inspiro:
DD.MM.YYYY or MM/DD/YYYY

- Enter the **Settings** menu and then select **Date & Time**.
- Select **Date format** and then press **OK**.
- Select the required date format by using the **Up** or **Down** key.
Then press **OK**.

The preferred date format has now been selected and the date at the top of the screen is now displayed in the new format.

The inspiro also offers two time formats:

24-hour clock

12-hour clock (am/pm)

- In order to select the desired time format, scroll down in the **Date & Time** menu and then select **Time format**. Then proceed in the same manner as when changing the date format.

7.3 Adjusting the settings of the LCD display

The settings of the inspiro's LCD display are pre-set. Should you wish to change the presets, please proceed as follows:

- Enter the **Settings** menu and then select **Display**.
- Select the **Backlight** menu to increase or decrease the level of brightness of the backlight of the LCD display.
- Select **Turn off light** to set the time when the inspiro should switch OFF the backlight in order to save power.
- Select **Turn off display** to set the time when the inspiro should switch OFF the LCD display to save power. The recommended setting is **never**.

You can also check the help in the inspiro menu for further information.

 **Always check the inspiro ON/OFF slider to determine whether the inspiro is either switched ON or OFF!**
If the inspiro is ON and the LCD display is OFF, the display will be black, whilst if the inspiro is ON and the background light is OFF, the LCD display will be dimmed!

If the inspiro is turned ON but the LCD display is OFF or the backlight is OFF, press the **OK** key to activate the LCD display!

7.4 Selecting a desktop picture

inspiro offers a choice of desktop pictures. One of these pictures is already active in your inspiro. If you wish to select another of the desktop pictures, then proceed as follows:

- Enter the **Settings** menu and then select **Desktop picture**.
- The LCD display shows the first desktop picture. Press the **Down** key once to see the next picture. Pressing the Down key again will show the other desktop picture. Once you have chosen your preferred picture, press the **Save** soft key.

7.5 Selecting your language

The inspiro offers a choice of different languages. Should you wish to change the current inspiro language, then proceed as follows:

- Enter the **Settings** menu and then select **Language**.
- You will now see the different languages available listed on the LCD display. The currently selected language is marked with a black dot. All of the other languages are marked with a light grey dot.
- Select the desired language using the **Up** and **Down** keys. Then press **OK**. An information window will pop up and then disappear automatically after 2 seconds. Alternatively, you can press **OK** to close the window immediately.

The new language has now been set. All of the menu items, help texts and information windows will now be displayed in the selected language.

8. Brief description of the menu items

inspiro can be used in the following operating modes:

- **Standard operating mode**

For standard use, as well as for use by all parents and teachers who do not require any special features.

- **Extended operating mode**

For all users who require access to special FM features, such as the MultiTalker Network, etc.

- **Light operating mode**

For users who do not need access to inspiro's menu.

inspiro's operating mode can be changed directly on the inspiro (see "Changing the application mode" on page 45).

Standard operating mode

8.1 Channels

- **Change channel**

Change the inspiro's transmitting FM channel by scrolling up or down through the FM channel list. You can select a new channel using the 'OK' key. FM receivers can be directly synchronized to the new channel by pressing the right soft key.

- **Find channel**

Finds a new, clean FM channel. All of the channels available in the inspiro are first checked and then the inspiro proposes the best channel for use. Follow the instructions in the inspiro!

- **Sync receivers**

Changes the FM channel on the receiver to the current inspiro channel. The receiver must be within arm's length. Beeping sounds confirm that synchronization is complete.

8.2 Receiver options

- **Monitor**

This performs a wireless check on the receivers. The inspiro should be kept close to the receivers. The receivers must be connected to a hearing device and the hearing device must be switched ON. A beeping sound marks the end of the check. Monitoring works only with Phonak Dynamic FM receivers.

- **Set beep tone**

Choose between the different beeping tones available to indicate when the Dynamic FM receivers are being synchronized or monitored.

- **Lock push button**

Locks or enables the push button on the universal MLxi receiver.

8. Brief description of the menu items

8.3 SoundCheck

- This check determines the volume level of speech and of background noise. Adjust the position of the iLapel microphone until you get the best result.

8.4 Settings

- **Language**
Choose the language of the inspiro menu.
- **Alarm**
Sets the alarm time. The alarm will sound every day at the set alarm time, but only if the inspiro is switched ON.
- **Date & Time**
Sets the current date and time and the date format and time format.

■ Softkeys

With inspiro transmitters running firmware version 3.0 or higher, the left and right soft keys can be programmed by the user.



To customize these soft keys, select "Settings" in the menu list and press "OK".

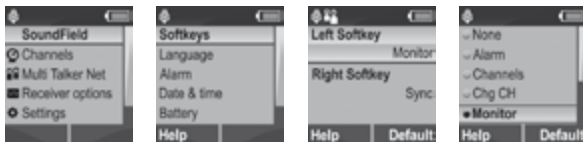

"Default" key is available to restore the default configuration for the selected soft key.

8. Brief description of the menu items

■ Audio input

To select the special audio input setting for certain audio devices, such as the iPod nano, go into the "Audio device" sub-menu. Select "Set microphone Mute" if you want to mute the iLapel or EasyBoom microphone when an audio input signal is detected.

■ Display

Set the backlight level, backlight turn-off time and display turn-off time.

■ Desktop picture

Choose your favorite of the different desktop pictures available.

■ Battery

View information about battery status.

8.5 Help

■ Instructions

Summarizes all the inspiro help texts.

■ www support

Displays a website that provides further useful FM information for teachers and parents.

■ Hotline

Provides the phone number to call in case you have questions or problems.

- **About inspiro**

Shows the device's serial number, the software version, the hardware version, the DSP setting and the menu setting (Standard/Extended).

Additional features in Extended operating mode

8.6 MultiTalker Network

- **MultiTalker Net**

If a network has already been set up, you can choose to start the MultiTalker Network mode. If you do not start the MultiTalker Network, you will remain in single teaching mode.

- **Stop MultiTalker Net**

Stop the MultiTalker Network mode if you want to return to single teaching mode.

- **Set up network**

Create a MultiTalker network. The network setting is automatically stored in the inspiro.

- **List of participants**

In the inspiro managing the network, you can check the names of other teachers or speakers in the MultiTalker network.

8. Brief description of the menu items

8.7 Receiver options

- **Scan for channels**

Searches for an existing transmission from another transmitter, e.g. if a speaker is already using an FM transmitter at a lecture or presentation.

- **Identify receivers**

Helps to identify a receiver. Relevant receiver data can be read and displayed in the inspiro LCD, e.g. the user of the receiver or the serial number.

- **View channels**

Displays the channels programmed into the receiver.

- **Change channel**

Change the channel in the receiver without changing the current inspiro channel. This can be useful if several working groups need to be created in a class.

- **Set FM volume**

Increase or decrease the volume of the Dynamic FM receiver.

9. Changing the application mode* (‘FM’, ‘SoundField’, ‘SoundField + FM’)

With inspiro Premium transmitters running firmware version 3.0 or higher, the application mode can be changed directly on the inspiro.

To change the application mode, switch inspiro ON. When the battery symbol appears, press “OK” and the left soft key (C) simultaneously (shown below), then press “OK” (D) again.

(C)



(D)



Select the application mode required



* applicable to inspiro Premium only!

10. DynaMic and accessories

DynaMic is supplied with the following accessories:

- Desk stand
- Clamp 3/8", 5/8"
- Colored rings (for easy microphone identification)

These accessories can be ordered separately.

① DynaMic microphone _____



② Desk stand with clamp _____



③ Colored rings (red, blue, green) _____



④ Charging unit _____



⑤ Replacement microphone head _____



11. Important DynaMic figures

General:

Operates only with inspiro on the MultiTalker Network

11.1 Operating time and charging

- Operating time if the battery is fully charged:
 - ▷ up to 10 hours
- Charging time for 80% charge
 - ▷ approx. 1 hour
- Charging time for 100% charge
 - ▷ approx. 2 hours

11.2 Operating range (FM transmission)

- Operating range (proximity to initiator inspiro):
 - inside 20 meters / 65 feet
- ⚠ High-powered electronic equipment, large electronic installations and metallic structures may impair and significantly reduce the operating range.

12. Controls

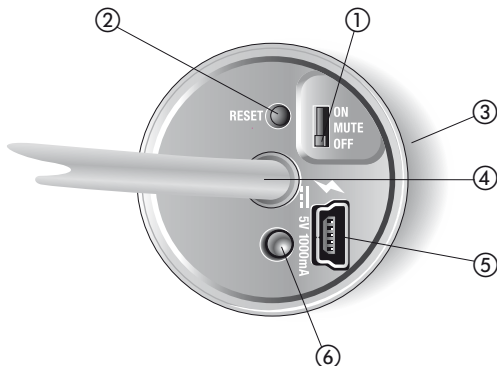

- ① **Slider OFF/MUTE/ON**
The slider puts DynaMic in one of its three modes.
- ② **RESET button**
This allows DynaMic to be reset. The parameters stored are not affected by this operation. Use a pen to press the button.
- ③ **Built-in vibration alarm**
The vibration alarm provides information on the status of the battery and operation.
- ④ **FM Antenna**
Emits FM to those FM receivers attached to hearing instruments.
- ⑤ **mini-USB interface**
Interface for charging and programming.
- ⑥ **The LED indicates the following:**
 - battery status
 - charging
 - error states

13. Getting Started

13.1 Charging DynaMic

DynaMic contains the same re-chargeable, state-of-the-art, fast-charging lithium polymer battery as inspiro. The operating time of this battery is up to 10 hours, depending on how much the microphone is used to pick up speech.

A fully-discharged battery takes one hour to charge up to 80% of its full capacity and two hours for a 100% charge.

⚠ Use only the original Phonak charging unit for inspiro/ DynaMic.

To simultaneously charge your inspiro and DynaMic we recommend using the twin charger.

Select an easily accessible power outlet and plug the charging unit into the socket.

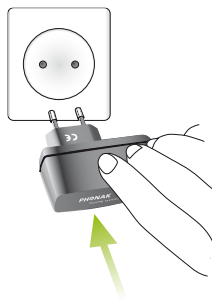
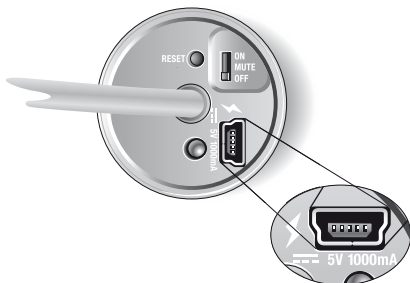

Connect the mini-USB plug from the charging unit to the DynaMic.

13. Getting Started

- During charging the LED flashes two short green pulses every 5 seconds.



When charging is complete, the LED displays a static green light.

 We recommend fully charging DynaMic. The battery cannot be over-charged.

13.2 Battery status indication

DynaMic activates an automatic vibration alarm when its battery level is low.

- Approx. 1 hour before the battery is empty: DynaMic should be charged.
The LED displays 3 orange flashes, repeated every 60 seconds and the vibration alarm is activated.



- Approx. 15 minutes before battery is empty: DynaMic must be charged immediately.
The LED displays 10 orange flashes and the vibration alarm is activated.
If the battery is not charged immediately, DynaMic's LED displays 10 flashes before switching OFF automatically.



13.3 Vibration alarm indication

DynaMic provides a vibration alarm if:

- The battery is low
- The device is out the range of the initiator inspiro in the MultiTalker Network further than 20 m / 65 feet
- The microphone is muted for more than 15 minutes
- There is no FM transmission – for instance, DynaMic is not paired
- A system error occurs – fast blinking orange LED signals and a vibration alarm

 In case of a system error, simply press the Reset button.

13. Getting Started

13.4 Switching ON DynaMic

DynaMic is a passaround microphone designed for use with inspiro in the MultiTalker Network. It is not a standalone FM transmitter.

To switch ON DynaMic, follow the steps below:

- inspiro and DynaMic are both OFF

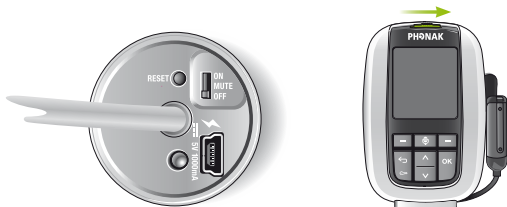

- Switch ON inspiro: push the slider to the left until the green mark appears and the LCD is activated (see page 23).
- Set-up the MultiTalker Network. Initiate your MultiTalker Network by pressing "OK".

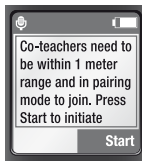

-
- Start DynaMic by pushing the slider from OFF to ON during the auto pairing time window of 8 seconds.

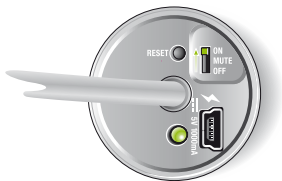

- After the initiation is complete, the name of DynaMic appears. Press OK.
DynaMic joins the MultiTalker Network as a secondary transmitter. It starts working as an FM transmitter.

After switching ON, the LED of the microphone turns off to save power.

On the initiating inspiro's list of participants the microphone can be recognized.

After pairing DynaMic with inspiro it is recommended to activate the key pad lock of inspiro whenever possible.

MUTE: When DynaMic is turned ON it is possible to mute the microphone. Switch the slider from ON to MUTE.

⚠ If DynaMic is not paired in the MultiTalker Network it does not start to emit FM.

14. Using DynaMic

14.1 Common use situations

- DynaMic situated on a child's desk, using the supplied table stand
- Holding DynaMic in the hand
- Wearing the remote mic with a lavalier – not supplied by Phonak
- Using a floor stand – not supplied by Phonak

14.2 Passaround microphone

DynaMic can be passed from one speaker to the next.

14.3 Talking

inspiro – Follow all the steps described in the chapter „Talking“, inspiro chapter page 27.

DynaMic – Make sure DynaMic:

- Is recognized into the MultiTalker Network by the initiator inspiro. You can check via the inspiro's LCD.
- Is within range of the MultiTalker Network
- Is turned ON
- Is not muted

Speak into the microphone at relatively close range, 5-30 cm / 2-12 inches.

-  **When speaking do not cover:**
- the head of the microphone
 - the antenna



14.4 Colored rings

With the red, blue and green rings it is possible to personalize your DynaMic for quick identification.

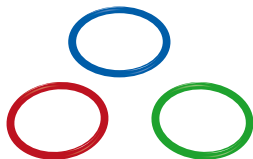

⚠ You may use only 2 rings on one DynaMic. Do not place these rings over the grill openings of the microphone's cap.

14.5 DynaMic DataLogging FM

DynaMic automatically logs its usage times. This information is saved every 15 minutes. The first log entry is stored after using DynaMic for 15 minutes. The usage data log contains information such as the device's name, timestamp, MTN mode etc.

DynaMic can store up to 800 data logs, covering approx. 20 days of usage.

14.6 Programming

Programming is optional. The frequency is automatically selected by the initiating inspiro in the MultiTalker Network.

The following parameters can be programmed using FM SuccessWare 4.3 software or higher:

- Name, school and date
- Firmware updates
- Reading and erasing logged data

15. The MultiTalker Network in school

15.1 The MultiTalker Network

One or more inspiro/DynaMic transmitters can participate in a MultiTalker Network (up to ten transmitters in total).

⚠ A maximum of nine additional transmitters can be used on the MultiTalker Network (MTN).

- The MultiTalker Network is available in the inspiro's Extended Operating Mode.
- The MTN's operating range – i. e. the distance between the initiating inspiro and each inspiro/DynaMic joining the network – is 20 m / 65 feet.
If a user should unintentionally leave the network, the inspiro or DynaMic's alarm will alert the user.

Diagram of the MultiTalker Network

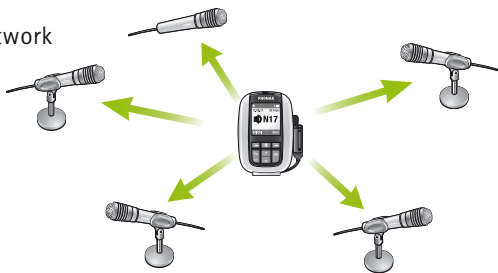

- The initiating inspiro displays a list of the other transmitters in the MultiTalker Network.

15.2 Initiating a MultiTalker Network

Initiating or setting up a MultiTalker Network should be performed in the classroom before the lesson begins. The procedure to follow is straightforward and the inspiro menu guides you through the necessary steps. See the chapter "Switching ON DynaMic" on page 52.

- Make sure you have all the inspiro and DynaMic transmitters you plan to include in the network in front of you on the desk. Ensure all these transmitters are switched OFF.
- Take the main teacher's or main speaker's inspiro and switch it on. In this inspiro, select MultiTalker Network and then Set up network. This inspiro is known as the "initiator".
- Read the information on the LCD display and then press the Start soft key.
- Next, switch on all of the other inspiro and DynaMic transmitters.
- A list of the inspiro and DynaMic transmitters that have joined the network should now be displayed on the initiating inspiro. If all of the transmitters are listed, press the Continue soft key.

You have successfully created a MultiTalker Network! All inspiro and DynaMic transmitters are paired by the initiator inspiro.

Begin talking as usual.

15. Multiple talkers in one classroom

15.3 How to use a MultiTalker Network

- The inspiro that has set-up (initiated) the network has first priority; all other transmitters inspiro/DynaMic that joined the network have second priority.
The teacher with first priority can interrupt any teacher or student that has second priority; a second priority teacher or student can only take over during the speech pauses of the first priority teacher.
- All devices transmit on the same FM channel, **but they do not transmit at the same time.**
- No user action is required; if the first priority inspiro does not detect speech, any second priority teacher or student can "get the microphone" just by starting to talk.
- The listening FM receivers only 'hear' one voice at a time.

15.4 Leaving a MultiTalker Network

The MultiTalker Network cannot exist without the presence of the initiating inspiro in the network. If you decide to end the Multi-Talker Network, the entire network will cease and all of the inspiro and DynaMic transmitters will activate their respective alarms.

If you are using an inspiro that just joined a network, you can always leave the network by selecting Stop MultiTalker Network. Your inspiro will then be set to single teaching mode, but all of the other inspiro transmitters in the MultiTalker Network will remain in MultiTalker Network mode.

If you switch OFF one DynaMic, it will be deleted from your participants list. The MultiTalker Network will continue with all other DynaMic and inspiro transmitters.

Should you unintentionally move outside the range of the MultiTalker Network, you will be alerted by an alarm. You can then choose to either return inside the network's operating range (i. e. within 20 m / 65 feet of the initiating inspiro), or leave the network.

15.5 Practical tips

- The MultiTalker Network setting is stored in the inspiro transmitters. If the inspiro and DynaMic transmitters have been switched OFF in MultiTalker Network mode, e. g. before lunch, when switched back ON again after lunch MultiTalker Network mode can be selected by simply turning on inspiro and pressing Continue. In this case, there is no need to re-initiate the network. All the DynaMic transmitters will join the network after the 8 seconds pairing window.
- If you have set up a MultiTalker Network with, for instance, two inspiro transmitters and a third person then needs to join the network with inspiro or DynaMic, you must initiate a new MultiTalker Network.
- inspiro and Dynamic transmitters joining a network automatically use the FM channel of the initiating inspiro in the MultiTalker Network.

15. Multiple talkers in one classroom

- If an inspiro reverts to single teaching mode, it automatically utilises the FM channel used previously.
- If the initiating inspiro alters the FM channel in MultiTalker Network mode for any reason, this new channel will automatically be sent to the other inspiro and DynaMic transmitters in the network and then activated.

15.6 Setting up a MultiTalker Network when using DigiMaster loudspeaker

Pre-Requisite: All secondary inspiro's for MTN should not be paired with any DigiMaster loudspeaker!

Before setting up MTN, select each inspiro's "SoundField", menu, then "Disconnect".

16. FM receivers

16.1 The MLxi

An FM system consists of a transmitter and FM receivers. The inspiro is an FM transmitter, while the MLxi is an FM receiver.

- The MLxi is a universal device and can be used with Phonak, as well as with nearly all other BTE brands.
- In order to connect an MLxi to the hearing device, you will need an audio shoe (audio boot).
- The Audio shoe is produced by the manufacturer of the hearing device. The user guide for your hearing device explains how to attach and remove the audio shoe from the hearing device.



Consult your hearing care professional if you have any questions regarding the connecting of the MLxi to the audio shoe and the hearing device.

16.2 Lock MLxi push button

The MLxi push button can be either locked or activated. This action can be performed by either the hearing care professional or the inspiro user.

- In this mode, the MLxi functions automatically.
- This mode is recommended for all children.

The required procedure is as follows:

- Select **Lock push button** in the **Receiver** menu.
- Make sure that the distance between the receivers and the inspiro is approximately 20 cm / 8 inches. Then use either the left soft key to **Lock** the push button or the right soft key to **Activate** the push button.
- Press the MLxi push button to check whether the setting has successfully been altered.

16.3 Identifying receivers

The inspiro is able to identify Dynamic FM receivers, e.g. an MLxi or ML10i. If it locates an MLxi, the inspiro can read the identification data and display it on the LCD display. This also helps in determining to whom the receiver belongs.

This feature is only available in the inspiro's Extended operating mode.

The required procedure is as follows:

- Make sure that the receiver is connected to a hearing device and that both the hearing device and the receiver are switched on and the FM program is activated in the hearing instrument.
- Ensure that the distance between the inspiro and the MLxi or ML10i is approximately 20 cm / 8 inches. Select **Receiver options** and then **Identify receivers**.
- The identification data should now be shown on the inspiro's LCD display.

This feature is particularly useful in schools.

16.4 Other Phonak FM receivers

inspiro/DynaMic are compatible with all Phonak FM receivers. If you have questions concerning a specific receiver, please consult your hearing care professional or visit:
www.eschooldesk.com

We do not recommend using the inspiro/DynaMic with FM receivers produced by other manufacturers.

17. Troubleshooting

17.1 inspiro

Problem

The inspiro cannot be switched ON.

Poor speech intelligibility.

Speaker's voice is inaudible even though the inspiro is turned ON.

Most probable cause	Solution
The battery is empty.	Charge the inspiro for a period of at least two hours.
The microphone has not been positioned properly.	Move the microphone closer to the speaker's mouth. Activate the SoundCheck feature.
The microphone mute has been activated or the hearing device has not been set to the right program.	Check the inspiro's LCD display and press the microphone mute key in order to activate the microphone. Also check whether the hearing devices are turned on and set to the right program. Activate the Monitoring function on the inspiro to check the receivers.

17. Troubleshooting

Problem

Insufficient operating range.

Radio interference.

A second person's voice can also be heard.

inspiro does not respond to commands.

Most probable cause	Solution
Microphone cable has not been unwound.	Unwind the microphone cable.
External cause: radio antenna or similar interfering devices nearby.	Change the FM channel. Use the ChannelFinder to locate an unused and interference-free FM channel.
Another FM user is using the same FM channel nearby.	Change the FM channel. Use the ChannelFinder to locate an unused and interference-free FM channel.
Software issue.	Reboot inspiro by pressing its 4 side buttons at the same time.

17. Troubleshooting

17.2 DynaMic

Problem

The DynaMic cannot be switched ON.

Poor speech intelligibility.

Speaker's voice is inaudible even though DynaMic is turned ON.

Most probable cause	Solution
The battery is empty.	Charge DynaMic for at least two hours.
The microphone has not been positioned properly.	Move DynaMic closer to the speaker's mouth.
DynaMic's antenna or cap are partially covered.	Uncover DynaMic's antenna and cap.
The colored rings are covering the acoustic openings.	Move DynaMic's colored rings off these openings.
DynaMic is muted or the hearing device has not been set to the right program.	<p data-bbox="539 810 938 841">Check DynaMic is not muted.</p> <p data-bbox="539 889 951 1003">Also check whether the hearing devices are turned ON and set to the right program.</p>

17. Troubleshooting

Problem

Radio interference.





A second person's voice can also be heard.









DynaMic cannot be found during MTN setup.

Most probable cause	Solution
Radio antenna or similar interfering devices are nearby.	Proceed as for inspiro.
Another FM user is using the same FM channel nearby.	Proceed as for inspiro.
Not compatible firmware version.	Upgrade firmware version.

18. Important notices

inspiro and DynaMic transmitters collect and store internal technical data. This data may be read by a hearing care professional in order to check the transmitters, as well as to support you in being able to use inspiro and DynaMic in the ideal manner.

-  Do not use your inspiro and DynaMic in a place where it is prohibited to use electronic devices. If in doubt, please ask the person in charge.
-  Persons with pacemakers or other medical devices should ALWAYS consult their physician, the manufacturer of their pacemaker, or other medical device BEFORE using inspiro and DynaMic. The use of inspiro with a pacemaker or other medical devices should ALWAYS be in accordance with the safety recommendations of the physician responsible for your pacemaker or the pacemaker manufacturer.
-  Do not use two or more inspiro transmitters on the same FM channel, except in the case of those transmitters being used on the MultiTalker Network.
-  Please note that radio signals might also be picked up and overheard by other receivers.
-  Before using the inspiro in a foreign country, contact your hearing care professional to ensure that the use of your radio channels is permitted in that country.

-
-  Do not use water or other liquids to clean inspiro or DynaMic.
 -  Use only original Phonak accessories.
 -  Use only the original Phonak charger for inspiro and DynaMic.
 -  inspiro and DynaMic should only be repaired by an authorized service center.
 -  Dropping inspiro or DynaMic can damage the transmitters.
 -  Do not place DynaMic's personalization rings over the acoustic openings of the microphone's cap.
 -  Do not cover the antenna or the microphone's cap while speaking.
 -  The microphone cap should **only** be opened for replacement purposes.
 -  Please note that with inspiro you can adjust the volume of the iSense Micro. Your hearing care professional must program your inspiro by selecting iSense Micro as FM receiver. This can be done with FM SuccessWare 4.2.1 or later.

19. Service and warranty

Local Warranty

Please ask the hearing care professional, where you purchased your devices, about the terms of the local warranty.

International Warranty

Phonak offers you a one year limited international warranty valid starting from the date of purchase. The limited warranty covers manufacturing and material defects in the device itself, but not accessories such as batteries. The warranty only comes into force if a proof of purchase is shown. The international warranty does not affect any legal rights that you might have under applicable national legislation governing sale of consumer goods.

Warranty Limitation

This warranty does not cover damage from improper handling or care, exposure to chemicals or undue stress. Damage caused by third parties or non-authorized service centers renders the warranty null and void. This warranty does not include any services performed by a hearing care professional in their office.

Serial number inspiro:

Serial number FM receiver:

Serial DynaMic:

Date of purchase:

Authorized hearing care professional
(Stamp/ signature):

20. Declaration of conformity

Hereby, Phonak Communications AG, declares that the inspiro and DynaMic are in compliance with the essential requirements and other relevant provisions of Directive 1999/5/EC.

To obtain a copy of the Declaration of conformity, please contact the manufacturer or the local Phonak representative whose address can be taken from the list on www.phonak.com (worldwide locations).

This device complies with part 15 and part 95 of the FCC rules and with RSS 210 of Industry Canada.

Operation is subject to the following two conditions:

(1) These devices do not cause harmful interference and (2) must accept any interference received, including interference that may cause undesired operation.

These transmitters are authorized by rule under the Low Power Radio Service (47 C.F.R. Part 95) and must not cause harmful interference to TV reception or United States Navy SPASUR installations.

You do not need an FCC license to operate these transmitters.

The transmitters may only be used to provide: auditory assistance to persons with disabilities, persons who require language translation, or persons in educational settings; health care services to the ill; law enforcement tracking services under agreement with a law enforcement agency; or automated maritime tele-communications system (AMTS) network control communications. Two way voice communications and all other types of uses not mentioned above are expressly prohibited.

⚠ Warning: Changes or modifications made to this equipment not expressly approved by Phonak may void the user's authority to operate the equipment.

21. Information and explanation of symbols



The CE symbol is confirmation by Phonak AG that this Phonak product meets the requirements of directive 93/42/EEC on medical devices and the R&TTE Directive 1999/5/EC on Radio and Telecommunication Terminal Equipment. The alert sign means that potential restrictions on its use are applicable in one or more EU Member States.



This symbol indicates that it is important that the user refers to associated warnings given in this user guide.



The symbol with the crossed out disposal bin indicates that these products shall not be treated as household waste. Please hand over your old or unused product to the applicable collection point for the recycling of electrical and electronic equipment or bring your old product to your hearing care professional for appropriate disposal. By ensuring these products are disposed of correctly, you will help prevent potential negative effects on the environment and human health.

Operating conditions

These products have been designed for trouble-free operation without restrictions when used as intended, unless otherwise stated in this user guide.

Transportation and storage conditions

Temperature should not exceed limits of $-20^{\circ}/60^{\circ}$ Celsius at a relative air humidity of 65% for extended periods during transportation and storage. Air pressure between 500 and 1100 hPa is not detrimental to these devices.



Personal notes

Manufacturer:
Phonak Communications AG
Laenggasse 17
CH-3280 Murten
Switzerland

EU Representative:
Phonak GmbH
D-70736 Fellbach-Oeffingen
Germany

www.phonak.com