

# Audéo YES

User Guide



AUDÉO **yes**™



CE  
0459

PHONAK

life is on

---

# Contents

<b>Welcome</b>	5
<b>Description</b>	6
<b>Preparation</b>	9
Replacing the battery	9
Identifying left and right Audéo YES	12
Inserting Audéo YES with xReceiver and dome into your ear	13
Closed domes	15
Inserting Audéo YES with Shell	17
<b>Operation</b>	20
Switching On/Off	20
<b>myPilot (optional)</b>	22
Fine tuning based on your personal preferences	24
<b>iCom (optional)</b>	25
EasyAudio and EasyBluetooth	26

<b>Maintenance</b>	27
Microphone Protector	27
Important points	29
<hr/>	
<b>Warning</b>	32
<hr/>	
<b>Service and Warranty</b>	33
<hr/>	
<b>Phonak distributors worldwide</b>	34
<hr/>	



---

# Welcome

Congratulations on choosing Audéo YES, the most sophisticated wireless communication device currently available. It uses the latest advances in digital sound processing to automatically adjust to your listening needs. Audéo YES provides the highest sound quality, speech understanding, listening comfort and wireless connectivity for all your personal communication situations. Its modern design is inconspicuous when worn and ensures optimal placement on the ear for best performance.

Audéo YES is a quality product developed by the Swiss company Phonak, a world leader in communication technology, innovation and reliability. Please read this manual carefully to benefit from all the features of Audéo YES. With proper care, Audéo YES will support your hearing and communication needs for many years.

If you want additional information about Audéo YES, please visit [www.phonak.com](http://www.phonak.com)

**Phonak – life is on!**

---

## Description

### Audéo YES with xReceiver and dome

- ① Microphone inputs with Microphone Protector
- ② Battery compartment with On/Off switch
- ③ xReceiver Unit
- ④ Retention (optional)
- ⑤ Dome

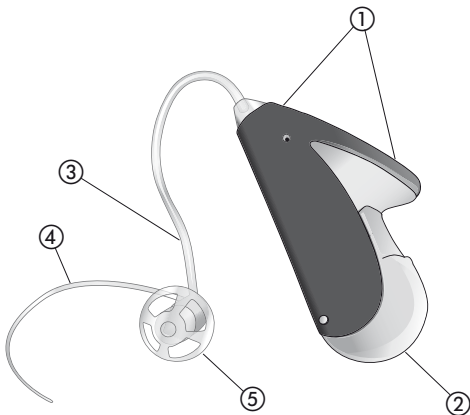

## Audéo YES with xReceiver and SlimTip

- ① – ③ See below
- ④ Individual SlimTip
- ⑤ Removal handle

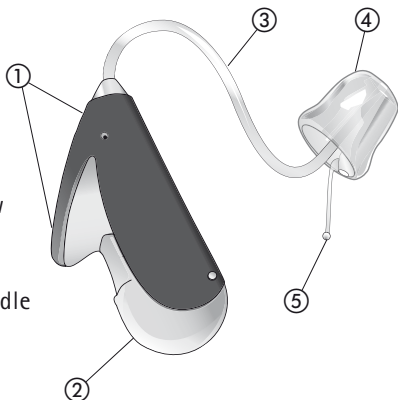

## Audéo YES with xReceiver Shell for custom fit

- ① Microphone inputs with Microphone Protector
- ② Battery compartment with ON/OFF switch
- ③ xReceiver Unit (sound output)
- ④ xReceiver Shell

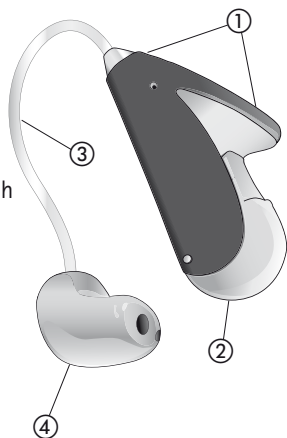

---

## Description

### Protective case

A special protective case is provided to securely store your Audéo YES instruments and batteries.

Store your Audéo YES in their protective case when not in use and leave the battery compartment in the OFF position (as described on page 20) to allow any moisture to evaporate. Remove the batteries if you will not be using them for an extended period of time.

- ① Left Audéo YES
- ② Right Audéo YES
- ③ Spare batteries

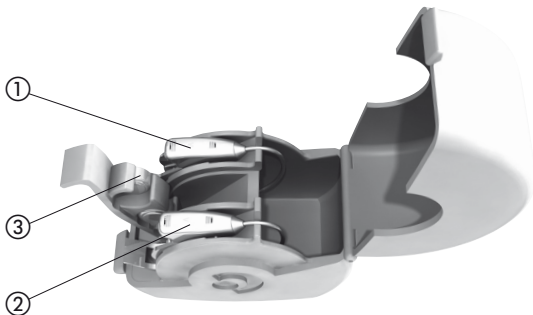



---

## Preparation

### Replacing the battery

Using the nail grip, open the battery compartment completely and remove the old battery.

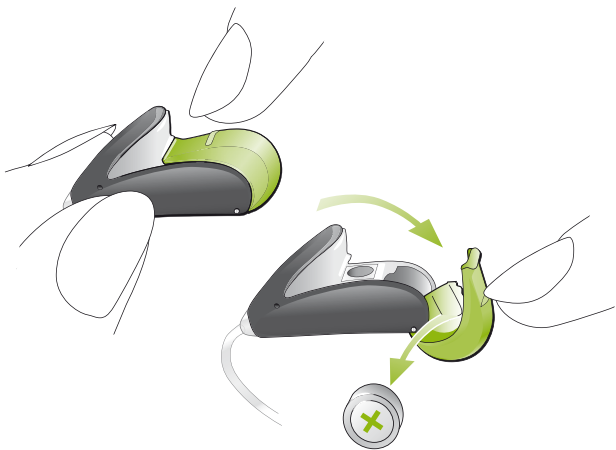

Remove the protective foil from the new battery. Wait for two minutes before inserting it.

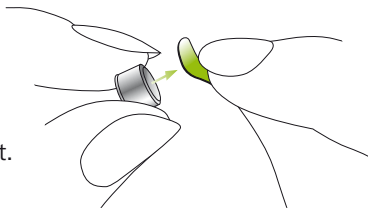



---

## Preparation

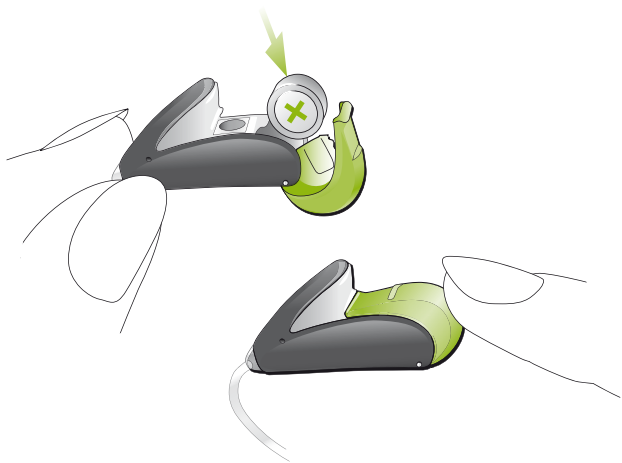
Insert the new battery with the "+" sign (flat side of the battery) in line with the correct battery orientation marked in the battery compartment and close it.



## Replacing the battery

-  Handle the battery compartment with care and do not use excessive force.
-  If there is any resistance when shutting the compartment, ensure that the battery is inserted correctly.

The compartment may not close properly if the battery is upside down and the instrument will not work.

-  When your Audéo YES is not in use, leave the battery compartment open to allow any moisture to evaporate.

### Low battery warning

An acoustic signal gives you an early warning that the battery is approaching exhaustion. Usually you have at least 30 minutes to replace the battery. With very high quality batteries, this reserve may be much higher and Audéo YES will repeat the low battery warning approximately every 30 minutes.

Please note that the battery consumption increases with regular use of the myPilot command center or the iCom communication interface.

---

## Preparation

### Identifying left and right Audéo YES

It is important to use the correct Audéo YES for each ear. Your hearing care professional can mark them for you with a color code placed in the battery compartment. The color code is visible when the battery compartment is opened.

It will identify left and right instruments as follows:

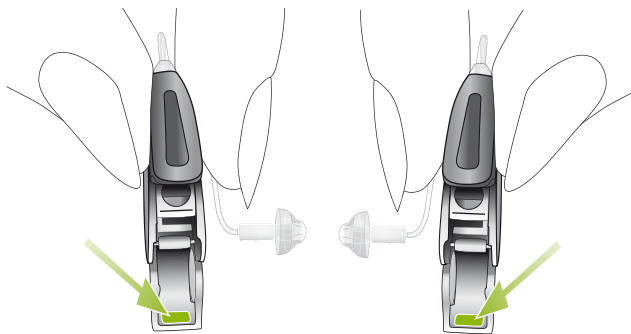

**blue =**  
**left Audéo YES**

**red =**  
**right Audéo YES**

## Inserting Audéo YES with xReceiver and dome into your ear

### Open domes

①

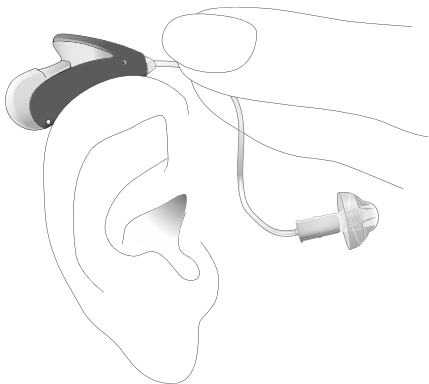

Place the Audéo YES over the top of your ear ①.

---

## Preparation

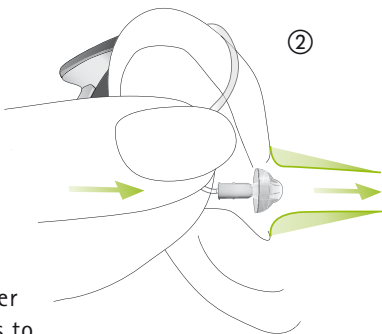

Hold the xReceiver where it attaches to the dome ② and gently push the dome into your ear canal.

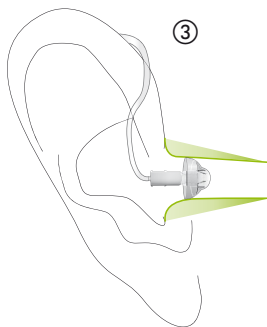

The dome should be placed far enough into the ear so that the wire of the xReceiver lies flush with your head ③.

## Closed domes

The closed dome consists of two fins overlapping each other. Before inserting the closed dome into the ear canal, it is important to check the position of these fins. The bigger fin must be positioned over the smaller fin, see picture ①. If the position is incorrect ②, you can easily adjust it. With one finger, just bend smoothly the bigger fin forwards and then back again so that it is overlapping the smaller one, see picture ③. Make sure also that the slit of the closed dome is in a horizontal position on the tube unit, as shown in picture ①.

Your xReceiver with closed dome is ready to be inserted into the ear, refer to page 13.

 In very rare cases, the dome can remain in the ear canal when removing the Receiver Unit from the ear. In the unlikely case that any parts remain in the ear canal, it is strongly recommended to see a medical specialist for safe removal.

---

Preparation

Correct position ①



Wrong position ②



Moving the fins ③

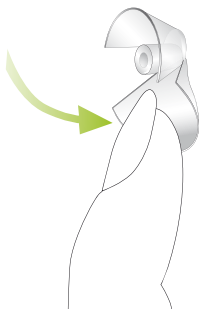



## Inserting Audéo YES with Shell

Using the hand on the same side you wear your hearing system, grasp the shell between your thumb and index finger.

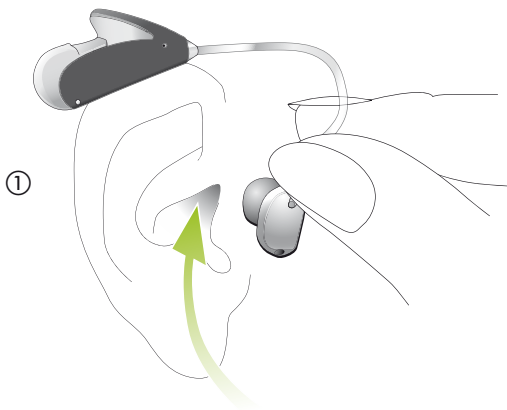

Raise your hand to your ear making sure the canal end of the shell faces your ear. Tilt your hand slightly forward ①.

---

## Preparation

Insert the canal end of the shell into your ear canal.  
Tug gently on your ear lobe and push the hearing system into the correct position ②.

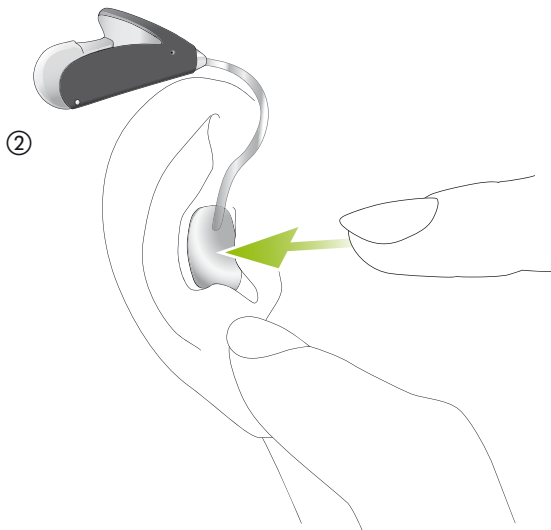

Now position the hearing system behind your ear.  
Be careful not to twist the tubing ③.

③

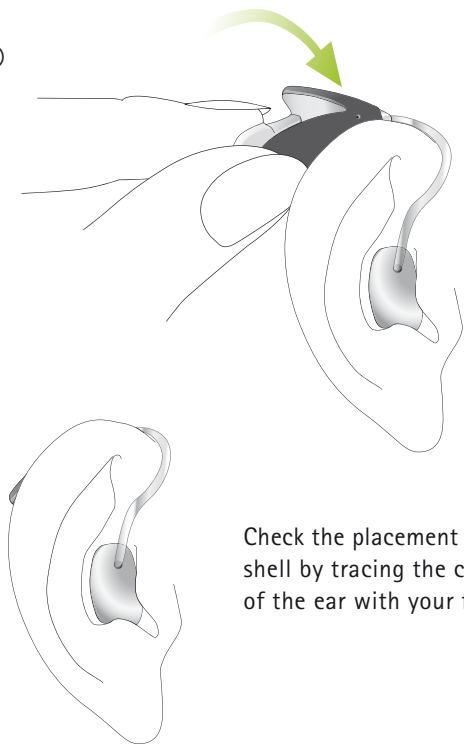

Check the placement of the shell by tracing the contour of the ear with your finger.

---

## Operation

### Switching On/Off

#### Switching Off

Using the nail grip, slightly open the battery cover until it snaps into its OFF position.

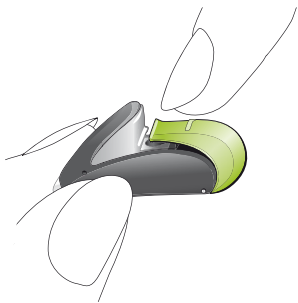

#### Switching On

Close the battery compartment by pressing on the base of the instrument.

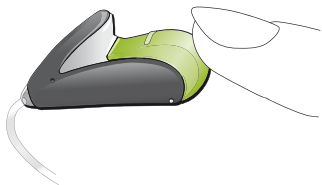



Please be aware of that your hearing instrument takes several seconds to boot up. Your hearing care professional may have activated a further delayed activation timer. This function delays the activation of the hearing system (for 9 or 15 seconds) after the battery door is closed in order to avoid any disturbance while placing it on your ear.

An acoustic signal confirms when your hearing system is switched on.

---

## myPilot (optional)

The myPilot command center is an optional accessory for Audéo YES hearing systems. It allows a convenient, user-friendly and discreet control of all the functions of your hearing system and additional benefits.

- Volume control
- Program selection
- Automatic mode selection
- Access to ZoomControl program
- Clock and alarm
- myPilot battery status
- Read out of hearing instrument volume, programs and battery status

For detailed information on the use of your myPilot, please refer to its user guide or ask your hearing care professional.

**myPilot:**  
available in two  
stylish colors,  
high-tech gray or  
white.



For optimum results, position your myPilot as shown in the drawing.

Operating range  
max. 50 cm (20")



 Do not use your myPilot in locations where it is forbidden to use electronic devices.

### ZoomControl

This special hearing program allows you to choose from four directions in which to focus your hearing system (front, back, left or right). ZoomControl can be accessed via the myPilot command center only.

---

myPilot (optional)

## Fine tuning based on your personal preferences

The fitting process has limited capabilities of reproducing the full spectrum of your personal sound environments. This limitation is overcome by the ability of the Audéo YES hearing system to learn from your real life volume adjustments. When used with a myPilot, Audéo YES offers a unique functionality called "Self Learning". In every environment, it logs your personal volume changes within the hearing system. This means that every time you change the volume of your Audéo YES hearing system, this correction is taken into account to apply your preferred volume automatically when you are in a similar environment next time.

Self Learning\* cleverly ensures that your volume corrections in each environment contribute to a fully personalized volume setting.

\*Audéo YES III does not have this function



---

## iCom (optional)

iCom is an optional accessory available for Audéo YES hearing systems. Automatically or with the push of a single button, iCom connects your hearing system with the technology around you.



### **Bluetooth connections**

iCom offers a simple way to connect your mobile phone via Bluetooth to your hearing system.

iCom is also capable of transmitting a stereo audio signal from any Bluetooth enabled device (built-in or via an adapter) such as MP3 players, laptops, computers or televisions.

---

iCom (optional)

## **EasyAudio and EasyBluetooth**

Your Audéo YES hearing system contains two special audio programs: EasyAudio and EasyBluetooth. These programs are automatically selected in your hearing system when an audio or Bluetooth signal is received from iCom. EasyAudio and EasyBluetooth ensure that you have the optimum program activated for streaming. An acoustic signal in your Audéo YES hearing instruments confirms the switch to either Easy program.

Please refer to the iCom user guide for more information on the numerous iCom applications.

---

## Maintenance

### Microphone Protector

**Important:** The Microphone Protector is an exclusive Phonak system designed to protect the Audéo YES high-tech microphones from debris. The Microphone Protector can be replaced if needed. Your Audéo YES instruments should not be used without the Microphone Protector.

Your hearing care professional can tell you whether the Microphone Protector should be exchanged or not.

---

## Maintenance

**Important:** Consult your Audéo YES specialist about changing the Microphone Protector if you experience any of the following:

- Audéo YES sounds quieter than usual
- There is a reduction in sound quality
- Understanding in noise becomes more difficult
- It becomes more difficult to determine the direction of sounds

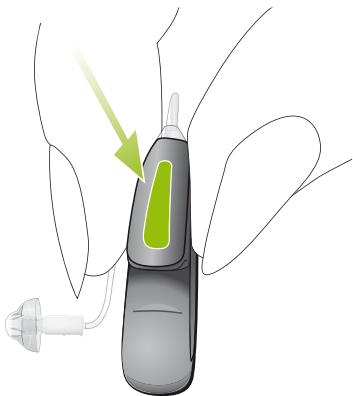

## Important points

- 1) Always use new batteries for your Audéo YES hearing system. You can return empty batteries to your hearing care professional.
- 2) When your hearing system is not in use, leave the battery compartment open to allow any moisture to evaporate.
- 3) If you will not be using your hearing system for a long period of time, store it in its protective case. Remove the batteries and leave the battery compartments open. Make sure your hearing system is completely dry before closing the case.
- 4) Protect your hearing system from excessive moisture and heat. Always remove it before showering, bathing or swimming. Do not leave the hearing system near windows or in a car. Avoid strong jolts and vibration.

---

## Maintenance

- 5) Daily cleaning and the use of a drying system is highly recommended. "C&C line" from Phonak is a complete set of cleansing products. Your hearing care professional will be glad to advise you. Never use household cleaning products (washing powder, soap, etc.) to clean your hearing system.
- 6) Hair spray, face creams and make-up can damage hearing systems. Remove the hearing system before applying cosmetics.
- 7) If you experience any soreness or inflammation in or behind your ear, contact your hearing care professional.
- 8) If your hearing system fails to operate after you have correctly inserted new batteries, contact your hearing care professional for advice. Please remember to bring your accessories (e.g. myPilot, iCom) together with your hearing system for service enquiries.







The symbol with the crossed out disposal bin indicates that this hearing system shall not be treated as household waste. Please hand over your old or unused hearing system to the applicable collection point for the recycling of electrical and electronic equipment or bring it to your hearing care professional for appropriate disposal.

By ensuring this product is disposed of correctly, you will help prevent potential negative effects on the environment and human health.

---

## Warning

-  **Hearing system batteries are toxic when swallowed!** Keep them out of reach of children and pets. If batteries are swallowed, please seek the advice of a medical practitioner!
-  **Only use hearing systems that have been specially programmed for you by a hearing care professional.** Other instruments may be ineffective and may, in certain cases, even damage your hearing.
-  **X-ray radiation (e.g. CT scans, MRI scans) may adversely affect the correct functioning of your system.** We recommend that you remove them before undergoing X-ray procedures and keep them outside the room.
-  **Hearing systems in directional microphone mode reduce mainly background sounds.** Warning signals coming from behind and vehicles' horns approaching from behind are partially or completely suppressed.
-  **Changes or modifications made to this equipment not expressly approved by Phonak are not allowed.**



---

## Service and Warranty

Phonak offers you a comprehensive global warranty which becomes effective on the date of purchase. Please ask your hearing care professional about the details and duration. This warranty covers any repairs due to defects in material and/or workmanship. The warranty does not cover damage from improper handling or care, exposure to chemicals, immersion in water or undue stress.

Damage caused by third parties or non-authorized service centers renders the Phonak warranty null and void. This warranty does not include any services performed by a hearing care professional in their office. This warranty applies to the Phonak products listed below:

Serial number  
instrument – right:

Serial number  
instrument – left:

---

---

Date of purchase:

Date of purchase:

---

---

---

## Phonak distributors worldwide

<b>Group companies:</b>	(detailed information on <a href="http://www.phonak.com">www.phonak.com</a> )
Australia	Phonak Australasia Pty. Ltd. Baulkham Hills N.S.W 2153
Austria	Hansaton Akustische Geräte GmbH 5020 Salzburg
Belgium	Ets Lapperre B.H.A.C. NV B-1702 Groot-Bijgaarden Phonak Belgium NV, B-1700 Dilbeek
Brazil	CAS Produtos Médicos São Paulo – SP 04363-100
Canada	Phonak Canada Limited Mississauga, Ontario L5W 0B3
China	Phonak (Shanghai) Co. Ltd. Shanghai City 200233
Denmark	Phonak Danmark A/S, Nitivej 10 2000 Frederiksberg
France	Phonak France SA, 69500 Bron
Germany	Phonak GmbH, 70736 Fellbach- Oeffingen, EC Representative
India	Phonak India Pvt. Ltd., 100 034 New Delhi
Italy	Phonak Italia S.r.l., 20159 Milano
Japan	Phonak Japan Co., Ltd., Tokyo 101-0044
Jordan	Phonak Middle East, 11181 Amman
Mexico	Phonak Mexicana, S.A. de C.V. 03920 México, D.F.MEXICO
Netherlands	Phonak B.V., 3439 ME Nieuwegein
New Zealand	Phonak New Zealand Ltd., Takapuna Auckland 9
Norway	Phonak AS, 0105 Oslo
Poland	Phonak Polska SP Z.O.O 00-567 Warszawa
Portugal	Phonak Ibérica S.A., 03008 Alicante, Spain

Russian Federation	Phonak CIS Ltd., Moscow, 115114
Spain	Phonak Ibérica S.A., 03008 Alicante
Sweden	Phonak AB, 117 43 Stockholm
Switzerland	Phonak AG, Phonak Schweiz, 8712 Stäfa
Turkey	Phonak Turkey A.S., 34357 Istanbul
United Kingdom	Phonak UK Limited Warrington, Cheshire WA1 1PP
USA	Phonak LLC, Warrenville, IL 60555-3927

**Independent general distributors:**

A complete list of Phonak distributors is available at Phonak's Internet site: **[www.phonak.com](http://www.phonak.com)**. Please visit us or ask your hearing care professional for information.

**Manufacturer:**

Phonak AG, Laubisrütistrasse 28  
CH-8712 Stäfa, Switzerland

---

## Notices

### Notice 1

This instrument is certified under:



FCC ID: KWC-WHSSAN  
IC: 2262A-SAN

This device complies with Part 15 of the FCC Rules and with RSS-210 of Industry Canada. Operation is subject to the following two conditions:

- 1) this device may not cause harmful interference, and
- 2) this device must accept any interference received, including interference that may cause undesired operation.

Changes or modifications made to this equipment not expressly approved by Phonak may void the FCC authorization to operate this equipment.

### Notice 2

This Class B digital apparatus complies with Canadian ICES-003.

### Notice 3

This equipment has been tested and found to comply with the limits for a Class B digital device, pursuant to Part 15 of the FCC Rules.

These limits are designed to provide reasonable protection against harmful interference in a residential installation. This equipment generates, uses, and can radiate radio frequency energy and, if not installed and used in accordance with the instructions, may cause harmful interference to radio communications. However, there is no guarantee that interference will not occur in a particular installation.

If this equipment does cause harmful interference to radio or television reception, which can be determined by turning the equipment off and on, the user is encouraged to try to correct the interference by one or more of the following measures:

- Reorient or relocate the receiving antenna
- Increase the separation between the equipment and receiver
- Connect the equipment into an outlet on a circuit different from that to which the receiver is connected
- Consult the dealer or an experienced radio/TV technician for help



The CE symbol is a confirmation by Phonak AG that Audéo YES products and accessories meet the requirements of directive 93/42/EEC on medical devices and the R&TTE Directive 1999/5/EC on Radio and Telecommunication Terminal Equipment.

The numbers after the CE symbol are the numbers of consulted certified bodies under the above mentioned directives. The alert sign means that potential restrictions on its use are applicable in one or more EU Member States.

---



This symbol indicates that Audéo YES products comply with requirements for a BF type applied part according to EN 60601-1. The surface of the hearing system is specified as applied part type BF.

---



This symbol indicates that it is important that the user refers to associated warnings given in this user guide.

---

#### **Safety notice**

External devices may only be connected if they have been tested in accordance with corresponding IECXXXXX standards. Only use accessories approved by Phonak AG.

---

#### **Operating conditions**

The product has been designed for trouble-free operation without restrictions when used as intended, unless otherwise stated in this user guide.

---

**Transportation and storage conditions**

Temperature should not exceed limits of  $-20^{\circ}/60^{\circ}$  Celsius at a relative air humidity of 65% for extended periods during transportation and storage. Air pressure between 500 and 1100 hPa is not detrimental to the instrument.

---

 **Z999** Australia & New Zealand

---

 **Brazil**

---

**CMI ID:** China

---

 **Japan**

---

 **South Korea**

---



[www.phonak.com](http://www.phonak.com)

029-0083-02/V1.00/2008-12/A+W Printed in Switzerland © Phonak AG All rights reserved