

Phonak Lyric™ 4.

User Guide for Lyric self-replacement procedure

Phonak Lyric4
Lyric SoundLync™



 These instructions do not replace, but complement the Lyric4 User Guide (reference 029-1328-02).



Contents

This user guide is valid for:

Non wireless hearing aid

Phonak Lyric4 (XXS)
Phonak Lyric4 (XS)
Phonak Lyric4 (S)
Phonak Lyric4 (M)
Phonak Lyric4 (L)
Phonak Lyric4 (XL)
Phonak Lyric4 (XXL)



Remote control and removal tool

Lyric SoundLync



Your hearing aid

- | | |
|---------------------|---|
| 1. Self-replacement | 5 |
|---------------------|---|

Further information

- | | |
|---|----|
| 2. Environmental conditions | 27 |
| 3. Information and explanation of symbols | 29 |
| 4. Important safety information | 35 |



Thank you for choosing Lyric, the first extended wear hearing aid that is 100% invisible, and with the option of self-replacement.

At its core, Lyric requires a lot less interaction and handling compared to conventional hearing aids. With self-replacement, we offer a way to reduce the dependency with your hearing care professional and make your life easier.

We are convinced that your Lyric will provide valuable benefits to your daily life.

Your hearing aids have been developed by Phonak – a world leader in hearing solutions based in Zurich, Switzerland.

Please read this user guide carefully in order to safely self-replace your Lyric hearing aids.

If you have any questions, please consult your hearing care professional.

Phonak – life is on
www.phonak.com

1. Self-replacement

The standard procedure for a Lyric refit or a device replacement is that your hearing care professional performs the refit for you.

Alternatively your Lyric hearing care professional can introduce you to the self-replacement procedure, which enables you to replace the device yourself in a very controlled way.

Self-replacement offers many advantages. Firstly, you don't have to travel to your hearing care professional every time you need new devices as you will be able to do the replacement yourself. Secondly, knowing that you have replacement devices, gives you the reassurance that you will benefit more from your hearing aids. It also gives you more control over your hearing, regardless of where you are.

Please note that self-replacement will not substitute all visits to your hearing care professional but only every second visit. This will ensure that you benefit from effective follow-up and after care service provided by your hearing care professional.

1.1 Self-replacement kit

Your hearing care professional will give you a Lyric self-replacement kit.

This kit contains:

- Carrying case
- If you wear Lyric in both ears, two pre-programmed Lyric devices are provided. These are switched off and clearly marked with left and right
- If you wear Lyric in one ear you will receive one pre-programmed Lyric device, switched off
- SoundLync (removal tool and remote control)
- User Guide for Lyric self-replacement procedure
- Your Lyric hearing care professional's business card, in case you need support

Additional material can be added at your hearing care professional's discretion.

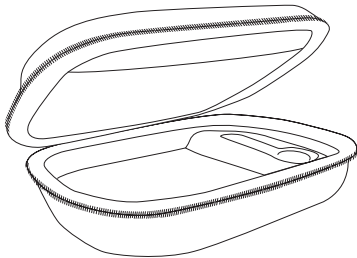

1.2 Important safety notes

1. Keep the devices in a temperature range of +10° to +40° Celsius (50° to 104° Fahrenheit). It is important that the devices are not stored in a cold place like the refrigerator or the freezer, or in a car where temperatures can vary and be extreme.
2. Prepare to exchange the devices when one or both of your devices stop working or when you feel the devices you are wearing sound quieter than normal.
3. Remove your devices with care to avoid injuring yourself in any way. Pack the devices separately, making a clear note of the left and right Lyric devices. Take them back to your hearing care professional for your next appointment. If you have experienced any issues with these removed devices, your hearing care professional can have a detailed look at them or send them back to Phonak for analysis.
4. Make sure that you remove the device from your ear before inserting a new one.

5. Optionally, to let your ear canals breathe, proceed with self-replacement of the new devices a few hours after having removed the old ones, unless recommended differently by your hearing care professional. This can help reduce any accumulation of moisture in the ears and keep the devices working for longer periods.
6. You have received training from your hearing care professional on how to replace your Lyric devices, it is not intended or recommended for anyone else to replace the devices in your ears.

1.3 Self-removal instructions

The following chapter provides instructions on how to use your Lyric. Please read it carefully.

Using the SoundLync

The SoundLync contains a small black magnet that functions like a remote control to change the settings of your Lyric.

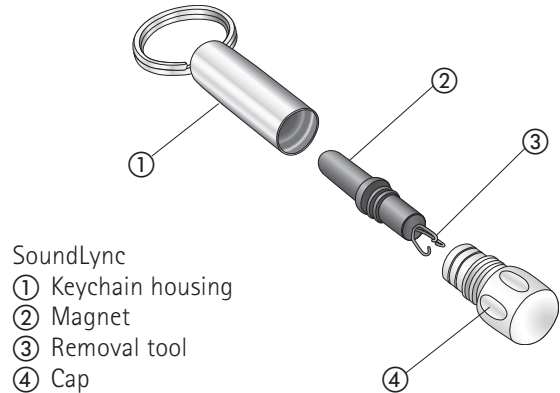

Removing Lyric

Step 1: Wash hands and prepare a clean work place, e.g. using a clean paper cloth.

Step 2: If Lyric is still working, turn it OFF using the magnet. To do so, hold the magnet inside the ear canal without touching the hearing aid until you hear 2 beeps. Continue to hold the magnet in place until you hear 4 more beeps (there is a short pause between the first 2 and the last 4 beeps).

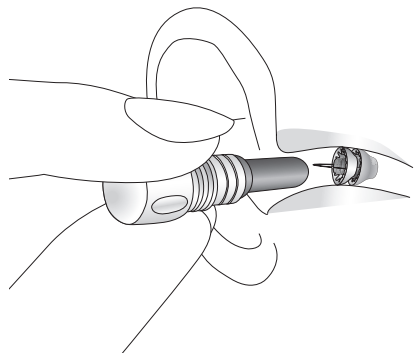

Step 3: Unscrew the cap on the magnet to expose the removal tool. Firmly hold the removal tool as you would hold a pencil, with your hand braced against your cheek. Slowly and gently insert the removal tool into the ear canal until it lightly touches the hearing aid.

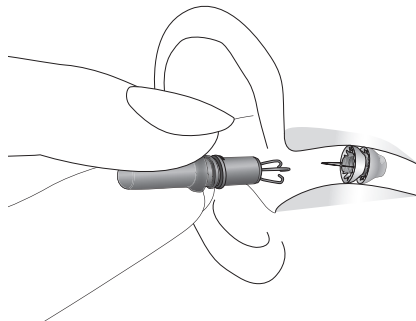

Step 4: Use a gentle circular motion to engage the removal loop. You should feel a slight resistance when you tug on it. Gently remove the hearing aid using a gradual circular motion.

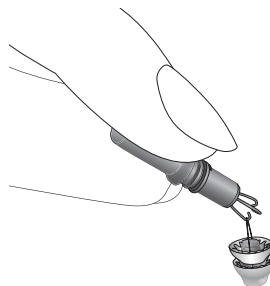
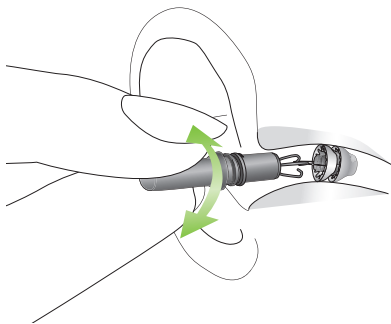

Note: Lyric can be removed using a blunt-nosed tweezer if the removal tool is not available. Use the tweezer to grasp the handle on the hearing aid and gently remove the hearing aid using a circular motion.

ⓘ If the device or part of the device cannot be removed, contact your hearing care professional for help.

Step 5: When the hearing aid is out of the ear, place it into its container and mark the date of removal. If you remove Lyric from both ears, please mark the side (left/right) on the containers. Please return the used hearing aid to your hearing care professional at your next visit.

If you are unable to safely remove the device, or the removed device is wet, dark, missing parts, or contains blood, blood clots, fluid or debris, or if you experience pain, discomfort, bleeding, fullness or pressure, or if your hearing appears worse than normal, do not replace, but seek advice from your hearing care professional.

1.4 Preparation of the new Lyric

Step 1: Check that the package of the new Lyric that you receive from your hearing care professional is neither opened nor damaged. If it is the case, we recommend not to use this device but to contact your hearing care professional for assistance.

Step 2: Unpack the new Lyric that you received from your hearing care professional during your last visit. Make sure that the device you unpack corresponds to the side (left/right) that you intend to replace. Your hearing care professional has written the side on the package of each device.

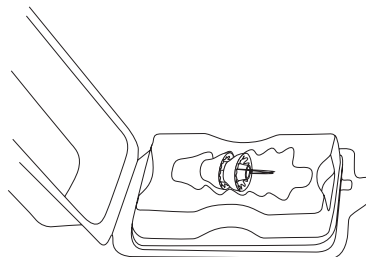

After removing the Lyric device you can dispose the pouches and the packs in the normal trash bin.

Step 3: To switch Lyric ON, place the black portion of the SoundLync tool close to the Lyric device until it beeps once. Then, immediately remove the SoundLync tool.

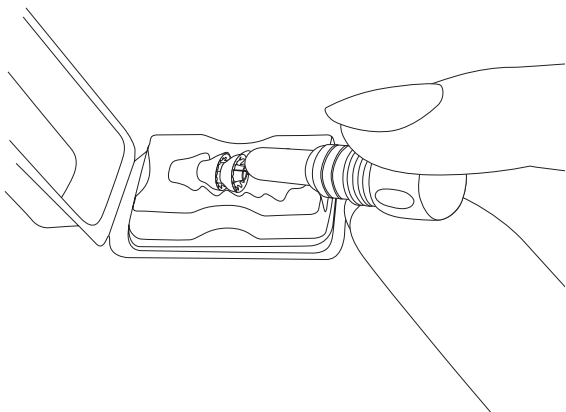

Step 4: Check to ensure the new Lyric device is turned on: The device should whistle in your closed hands.



1.5 Insertion

Step 1: Hold Lyric lightly between thumb and forefinger with the hand on the same side of the ear you will insert Lyric (right hand - right ear, left hand - left ear).

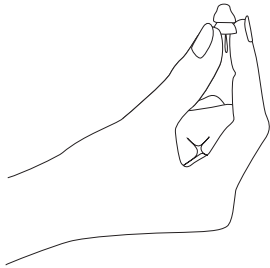

Orient the device as follows:

- The blue removal loop should face towards your hand. Once Lyric has been inserted in your ears, the blue removal loop should face the outside.
- The black dot on the outer yellow foam should be facing upwards.



Step 2: Tilt the head to the opposite side you are holding Lyric.



If you intend to insert Lyric in your right ear, tilt the head to the left.

If you intend to insert Lyric in your left ear, tilt the head to the right.

Step 3: Optionally, check that the Lyric is correctly positioned at the entrance of the ear canal using a mirror or asking a third person.



Step 4: Place Lyric at the entrance of the ear canal. Ensure your neck and shoulders are relaxed. During insertion do not move your wrist joint but only your elbow and shoulder.

The blue removal loop should face outwards from the ear.

The black dot on the seal should face upward toward the sky.



Step 5: Press Lyric with your thumb, until it is secure in the opening of your ear canal.

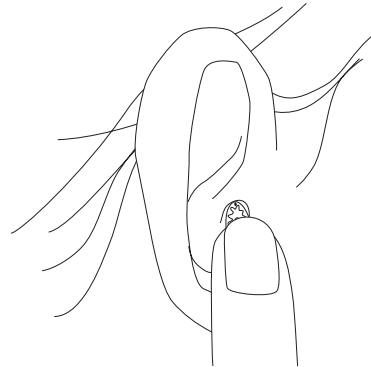

Step 6: Hold pinky/little finger and thumb at a 90° angle.

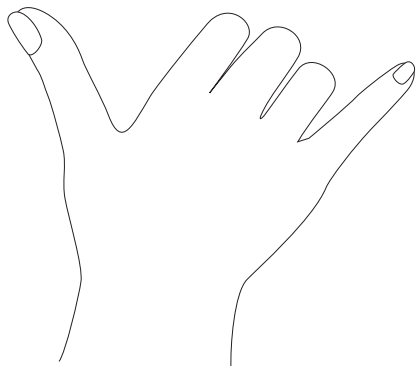

Step 7: Use pinky/little finger to slowly advance Lyric to the final insertion.

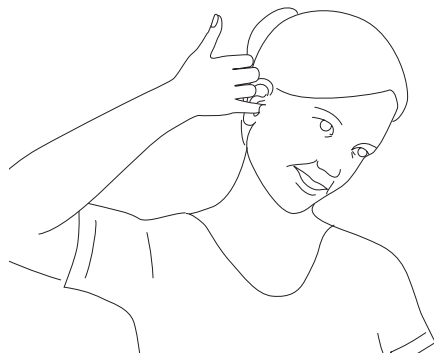

Step 8: You should feel when Lyric is correctly positioned: it should feel comfortable and it should sound familiar.

If you need to, push the Lyric with your pinky/little finger slightly further until it feels that it is inserted to the correct depth and is comfortable. You should hear as you did before.

In case it does not feel comfortable or the sound does not feel normal, you can remove Lyric and try to insert it again.

If you cannot insert Lyric as wished, or if you are not satisfied with how it feels or sounds, contact your Lyric hearing care professional for an appointment.

Note: Notify your Lyric hearing care professional at your earliest convenience that you have successfully replaced your Lyric to book an appointment for the next replacement.

2. Environmental conditions

The product is designed such that it functions without problems or restrictions if used as intended, unless otherwise noted in this user guide.

Please ensure to use, transport and store the hearing aids according to the following conditions:

Phonak Lyric4 hearing aids

| | Operating | Transport | Storage |
|------------------------------|-------------------------------------|-----------------------------------|-------------------------------------|
| Temperature | +10° to +40° C (+50° to +104° F) | 0° to +50° C (+32° to +122° F) | +10° to +40° C (+50° to +104° F) |
| Humidity (non condensing) | 5% to 85% | up to 72% | up to 72% |
| Atmospheric pressure | 700 to 1060 hPa | 500 to 1100 hPa | 700 to 1060 hPa |

This hearing aid is classified as IP44. This means that the hearing aid is protected against splashing of water. Lyric is water resistant, not waterproof, and should not be completely submerged underwater. Lyric may be worn while showering.

If the device has been subject to storage and transport conditions outside of the recommended use conditions, do not use the device.

3. Information and explanation of symbols



With the CE symbol, Sonova AG confirms that this product – including accessories – meets the requirements of the Medical Devices Regulation (EU) 2017/745. The numbers after the CE symbol correspond to the code of the certified institutions that were consulted under the above-mentioned directive.



This symbol indicates that the products described in these user instructions adhere to the requirements for an applied part of Type B of EN 60601-1. The surface of the hearing aid is specified as an applied part of Type B.



Indicates the medical device manufacturer, as defined in Medical Devices Regulation (EU) 2017/745.



Indicates the authorized representative in the European Union. The EU REP is also the importer to the European Union.



This symbol indicates that it is important for the user to read and take into account the relevant information in these user guides



This symbol indicates that it is important for the user to pay attention to the relevant warning notices in these user guides.



Important information for handling and product safety.



During transportation keep dry.



Indicates that the device is a medical device.



The symbol with the crossed out number two indicates that this hearing aid is for single use only. Do not reuse. Return your used Lyric to a Lyric trained hearing care professional.



Indicates the manufacturer's serial number so that a specific medical device can be identified.



Indicates the manufacturer's catalogue number so that the medical device can be identified.



Indicates the temperature limits to which the medical device can be safely exposed.
Temperature during transportation:
0° to +50° C (+32° to +122° F).
Temperature during storage:
+10° to +40° C (+50° to +104° F).
Operating conditions:
+10 to +40 °C (+50° to +104° F).



Indicates the range of humidity to which the medical device can be safely exposed.
Humidity transportation: Up to 72%.
Humidity storage: Up to 72%.
Operating conditions:
5-85% rH non condensing
(up to 95% non condensing for <2h).



Indicates the range of atmospheric pressure to which the medical device can be safely exposed.

Atmospheric pressure during transportation:
500 hPa - 1100 hPa
Operating and storage conditions:
700 hPa - 1060 hPa.



The symbol with the crossed-out garbage bin is to make you aware that this hearing aid may not be thrown away as normal household waste. Please dispose of old or unused hearing aids at waste disposal sites intended for electronic waste, or give your hearing aid to your hearing care professional for disposal. Proper disposal protects the environment and health.

B72



These symbols represent the two packets that are packed with the Lyric hearing aid in the shipping pouch. These packets ensure an optimal environment for the Lyric battery during shipping and storage.



After opening the shipping pouch, throw the two packets away immediately.



Do not open the two packets.



Do not ingest the contents of the two packets.



Indicates the date after which the medical device is not to be used.



Indicates the date when the medical device was manufactured.



This symbol indicates a device that is not safe to use in magnetic resonance (MR) environment (e.g. during an MRI scan).

IP44

IP Rating = Ingress Protection Rating.
IP44 rating indicates that the device is protected against solid foreign objects of 1.0 mm diameter and greater and is additionally protected against splashing of water.



Indicates a device's compliance with applicable Radio Spectrum Management's (RSM) and Australian Communications and Media Authority (ACMA) regulatory arrangements for the legal sale in New Zealand and Australia.



This symbol indicates that it is important for the user to pay attention to the relevant warning notices related to batteries in these user guides.

4. Important safety information

Please read the relevant safety information and limitations of-use information on the following pages before using your hearing aid.

Intended use:

Hearing aid: The hearing aid is intended to amplify and transmit sound to the ear and thereby compensate for impaired hearing.

SoundLync: The SoundLync is intended to remove the Lyric hearing aid, change the Lyric hearing aid mode (ON, OFF, SLEEP) and adjust the volume.

Intended patient population:

Hearing aid: The device is intended for people with unilateral and bilateral hearing loss from 18 years of age, who fulfill the clinical indication for this product.

SoundLync: The intended patient population is the user of the compatible hearing aids.

Intended patient population for self-replacement procedure:

The target population is identical to Lyric4 hearing aid's.

Intended user:

Hearing aid: Intended for people with hearing loss using a hearing aid. A Lyric certified hearing care professional is responsible for adjusting the hearing aid.

SoundLync: Intended for people with hearing loss using the compatible hearing aids and Lyric certified hearing care professional.

Clinical benefit:

Hearing aid: Improvement of speech understanding.

SoundLync: SoundLync itself does not provide a direct clinical benefit. An indirect clinical benefit is provided by enabling the parent device to achieve their intended purpose.

Side effects:

Hearing aid: Potential physiological side-effects of hearing aid use may include tinnitus, dizziness, wax build up, excessive pressure, sweating or moisture, blisters, itching and/or rashes, plugged or fullness and their consequences like headache and/or ear pain.

Hearing aids also have the potential to expose patients to higher levels of sound which might result in hearing threshold shifts in the frequency range affected by acoustic trauma. Extended wear hearing aids may also be associated with skin irritation (e.g., redness), infec-

tious or non-infectious otitis externa, and soft-tissue injuries such as abrasions, bruising, skin growth, bulge, swelling, bleeding or ulceration.

SoundLync: Please note, side effects are not derived from the SoundLync, but from the compatible hearing aids.

Indications:

Clinical indications for the use of hearing aids and SoundLync are:

- Presence of hearing loss
 - Uni- or bilateral
 - Conductive, sensorineural or mixed
 - Mild to moderately severe

Contraindications:

Hearing aid: Clinical contraindications for the use of hearing aid are:

- Deformity of the ear (i.e. closed ear canal; absence of the auricle)
- Evidence of active or chronic middle or outer ear pathology, chronic drainage or discharge, evidence of chronic inflammation
- Evidence of middle ear conditions such as tympanic membrane perforation, cholesteatoma, and pressure equalizer tubes

- Radiation therapy to the head or neck
- Neural hearing loss.

Additional clinical contraindications for the use of the self-replacement procedure with the device:

- Dementia or other cognitive impairment
- SoundLync: Please note, contraindications are not derived from SoundLync, but from the compatible hearing aids.

The primary criteria for the referral of a patient for a medical or other specialist opinion and / or treatment are as follows:

- Visible congenital or traumatic deformity of the ear.
- History of active drainage from the ear in the previous 90 days;
- History of sudden or rapidly progressive hearing loss in one or both ears within the previous 90 days
- Acute or chronic dizziness.
- Audiometric air-bone gap equal to or greater than 15 dB at 500 Hz, 1000 Hz and 2000 Hz;
- Visible evidence of significant cerumen accumulation or a foreign body in the ear canal.
- Pain or discomfort in the ear;
- Abnormal appearance of the eardrum and ear canal such as:

- Inflammation of the external auditory canal,
- Perforated eardrum.
- Other abnormalities which the hearing care professional believes are of medical concern

The hearing care professional may decide that referral is not appropriate or in the best interests of the patient when the following applies:

- When there is sufficient evidence that the condition has been fully investigated by a medical specialist and any possible treatment has been provided.
- The condition has not worsened or changed significantly since the previous investigation and / or treatment

If the patient has given their informed and competent decision not to accept advice to seek a medical opinion, it is permissible to proceed to recommend appropriate hearing aid systems subject to the following considerations:

- The recommendation will not have any adverse effects on the patients' health or general wellbeing;
- The records confirm that all necessary considerations about the patient's best interests have been made.
- If legally required, the patient has signed a disclaimer to confirm that the referral advice has not been accepted and that it is an informed decision.

Prior to the use of Lyric, please clarify with your hearing care professional and/or your medical doctor (general practitioner or ears, nose and throat medical doctor) to check if you are a candidate for Lyric and no contraindications are present.

A hearing aid will not restore normal hearing and will not prevent or improve a hearing impairment resulting from organic conditions. Infrequent use of a hearing aid does not permit a user to attain full benefit from it.

The use of a hearing aid is only part of hearing habilitation and may need to be supplemented by auditory training and instruction in lipreading. Feedback, poor sound quality, too loud or too soft sounds, inadequate fitting or problems when chewing or swallowing, can be resolved or improved during the fine-tuning process at the fitting procedure by your hearing care professional.

The hearing aid is suitable for the home healthcare environment and due to their portability it may happen that it is used in professional healthcare facility environment like physician offices, dental offices, etc. Any serious incident that has occurred in relation to the hearing aid, should be reported to the manufac-

turer representative and the competent authority of the state of residence. The serious incident is described as any incident that directly or indirectly led, might have led or might lead to any of the following:

- a) the death of a patient, user or other person
- b) the temporary or permanent serious deterioration of a patient's, user's or other person's state of health
- c) a serious public health threat

To report an unexpected operation or event, please contact the manufacturer or a representative.

4.1 Hazard warnings

- ⚠ The hearing aids (specially programmed for each hearing loss) must only be used by the intended person. They should not be used by any other person as they could damage hearing.
- ⚠ If you feel pain in or behind your ear, if it is inflamed, if skin irritation or accelerated accumulations of ear wax occur, please check with your hearing care professional or physician. Continued use under these conditions may lead to bone exposure. When to call your Lyric trained hearing care professional:
 - If the hearing aid malfunctions.
 - If you experience pain beyond the initial discomfort.
 - If you experience a sudden or significant change in your hearing.
- ⚠ Changes or modifications to the hearing aid that were not explicitly approved by Sonova AG are not permitted. Such changes may damage your ear or the hearing aid.
- ⚠ The SoundLync contains a magnet. If you use a medical device like a pacemaker or ICD device (implantable cardioverter defibrillator), please read the specific user guide to clarify possible impact of magnetic fields to your medical device. Do not place the SoundLync in your breast pocket. Keep a distance of at least 15 cm (6 inches) between the SoundLync and your medical device.
- ⚠ The hearing aid is a small device and contains small parts. This hearing aid is not for children and should be kept out of reach of children due to danger of swallowing. Do not leave individuals with cognitive impairment unsupervised with this hearing aid. Individuals with cognitive impairment should be supervised at all times to ensure their safety. If swallowed, consult a physician or hospital immediately as the hearing aid or its parts can cause choking!
- ⚠ Do not use the device in explosive areas (mines or industrial areas with danger of explosions, oxygen-rich environments or areas where flammable anesthetics are handled).

- ⚠️ If Lyric stops working for any reason, it must be removed within 24 hours, and a Lyric trained hearing care professional should examine your ear canal.
- ⚠️ Do not put cotton swabs or anything else in your ear canal. They could damage the hearing aid and/or injure your ear.
- ⚠️ Do not skydive, scuba dive or dive underwater. Diving while wearing Lyric may cause injury to your ear or damage to the hearing aid.
- ⚠️ When holding the SoundLync in the ear canal, make sure to insert it slowly and with caution. Avoid any movement of the hearing aid as this can injure your ear and/or damage the hearing aid.
- ⚠️ If you experience itching, redness, blisters, swelling, inflammation in or around your ears, inform your hearing care professional and contact your physician.

- ⚠️ Patients implanted with magnetic externally programmable CSF shunt valves may have a risk of experiencing an unintended change in their valve setting when exposed to strong magnetic fields. The receiver (loudspeaker) of hearing aids, the Lyric SoundLync, the Lyric programming wand and the MiniControl contain static magnets. Keep a distance of 2 inches (approx. 5 cm) or more between the magnets and the site of the implanted shunt valve.
- ⚠️  **WARNING:** Device batteries are hazardous and can cause serious injuries if they are swallowed or placed inside any part of the body, whether the battery is used or new! Keep out of the reach of children, individuals with cognitive impairment, or pets. If you suspect that a battery was swallowed or placed inside any part of the body, immediately consult your physician without any delay!
- ⚠️ Lyric is water resistant, not waterproof, and should not be completely submerged underwater. Do not submerge your head unless you wear a custom made earplug to protect Lyric from water exposure.

- ⚠ Once Lyric is removed, it cannot be reinserted.
- ⚠ Medical imaging procedures, such as MRI scans, may adversely affect the correct functioning of your hearing aid. Lyric must be removed before you have an MRI scan because it contains metallic parts. Please see chapter 4 in the user guide for detailed information concerning CT scans or X-ray procedures.
- ⚠ Be careful when choosing the SLEEP or OFF mode as you may not hear alarm signal in case of an emergency.
- ⚠ The hearing aid is a potential choking or swallowing hazard so it should be kept out of reach of children, mentally challenged people and pets. If hearing aids are swallowed, consult your medical practitioner immediately!
- ⚠ If pushed too deep Lyric can lead to tympanic membrane (eardrum) issues like perforation or haematoma (bruising). If you experience pain or notice blood on your Lyric device do not reinsert or further push Lyric into your ear canal and contact your HCP or physician.

⚠ **CAUTION:** You might need medical help if a piece gets stuck in your ear. If any part of your hearing aid, like the eartip, gets stuck in your ear, and you can't easily remove it with your fingers, get medical help as soon as you can. You should not try to use tweezers or cotton swabs because they can push the part farther into your ear, injuring your eardrum or ear canal, possibly seriously.

4.2 Information on product safety

- ⓘ The surface of the SoundLync is nickel free but the keyring is not. Therefore, the keyring should not rest against the skin of those with allergies to nickel. For these clients, it is recommended to remove the keyring prior to using the SoundLync.

Your hearing care professional:



EU REP

Sonova Deutschland GmbH
Max-Eyth-Strasse 20
70736 Fellbach-Oeffingen
Germany

Australian Sponsor:

Sonova Australia Pty Ltd
12 Inglewood Place,
Norwest NSW 2153
Australia



Manufacturer:

Sonova AG
Laubisrütistrasse 28
CH-8712 Stäfa
Switzerland

www.phonak.com

sonova
HEAR THE WORLD



CE
0459



7 613389 690897

029-1329-02|V2.00|2026-04|ZT © 2024-2026 Sonova AG All rights reserved